

# ELEMENTI MODULARI / MODULAR ELEMENTS MORSE - VISES





# VALIGETTA DI CAMPIONATURA STD (Art.1) SAMPLE KIT CASE STD (Art.1)

**NEW!**



**Art. 981**

Valigetta di campionatura morsa Art.1 T.1  
Sample kit case Art.1 T.1 vise

Cod.	0.98.10000

All'Interno - Inside:			
	Art.132		Art.313
	Art.133		Art.314
	Art.138		Art.271
	Art.147		Art.283
	Art.212		-
	Art.217		-
			Art.298
			Art.370
			Art.375
			Art.376

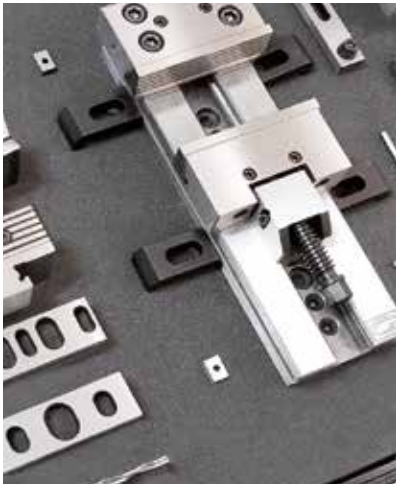

3

## SIMBOLOGIA DATI TECNICI TECHNICAL DATA ICONS

GANASCE JAWS		Fissa Fixed		Mobile Movable		Intermedia Intermediate		Fissa con piastra singola Fixed with single plate		Fissa con piastra doppia Fixed with double plate
PIASTRE GANASCE JAW PLATES				Discendente Pull down		Piane Straight		Cambio rapido manuale Quick manual change		GRIP GRIP
POSSIBILITÀ DI POSSIBILITY OF		Serraggio di 1 particolare Clamping only 1 piece		Serraggio di 2 particolari Clamping 2 pieces		Montaggio sul fianco o in serie Side mounting or gang operation		Posizionamento & cambio rapido Quick change & positioning		Cubi-morsa Vise tower
PAGINE PAGES						Accessori & Ricambi Accessories & Spare Parts		Istruzioni corretto utilizzo Instruction for a proper use		Diagrammi forze di serraggio Clamping force diagrams

## ELEMENTI MODULARI MODULAR ELEMENTS

**Sono la parte mobile e la parte fissa della morsa Stadar sezionate e rese completamente indipendenti per ottenere una versatilità estrema.**

**Are simply standard vises sections, the movable section and the fixed one, which in this way result completely independent for an extreme versatility.**

Gli elementi modulari **GERARDI** Vi permettono di ottimizzare i bloccaggi di pezzi particolarmente grandi, che richiedano le lavorazioni più gravose, sfruttando anche il piano della tavola della macchina come punto di appoggio. Gli elementi modulari sono sicuramente l'esempio (vedere applicazioni alle pagine seguenti) più lampante dell'estrema versatilità del sistema modulare Gerardi. La disponibilità di una vastissima gamma di composizioni (modulari) permette di realizzare con soluzioni standard anche gli allestimenti che credevate speciali

La morsa **GERARDI** sono ormai considerate sinonimo di produzione ad alto livello tecnologico per l'accurata scelta dei materiali impiegati e per la precisione raggiunta anche nei minimi particolari. **Accuratamente rettificate** in ogni loro particolare ed ampiamente collaudate, consentono:

✓ una capacità di massimo rendimento della macchina / ✓ un forte carico di pressione / ✓ una maggiore potenza di taglio / ✓ esclusione totale di vibrazioni / ✓ minor usura dell'utensile / ✓ una più precisa lavorazione

La costruzione con un sistema di elementi componibili consente le più svariate possibilità di impiego e combinazioni in caso di necessità.

**GERARDI** modular elements allow you perfect clamping even of big workpieces which need the heaviest machining using the machine table as surface.

Modular elements are the best example of the extreme versatility of the Gerardi modular system. The availability of the broadest assortment program allows to build with standard solutions even the fixtures you thought special. They are a solution for a lot of applications and, with the many reference points available, a perfect complement or alternative to single or double vises.

**GERARDI** vises are manufactured under rigid quality control. Only the most suitable materials are used, and the accuracy of the even the smallest components is assured. As a result of the high standard construction Gerardi vises can maintain their accuracy under the most severe operating conditions. **Hardened and ground steel construction throughout allowing you maximum machine performance** with:

✓ bigger clamping power / ✓ bigger cutting performances / ✓ total exclusion of vibrations / ✓ lower tool wear  
✓ higher precision during machinework

The modular design and the concept of interchangeability makes possible a wide variety of set up combination and solutions.



### CARATTERISTICHE E VANTAGGI

- USURA INESISTENTE
- RAPIDITA' DEI SERRAGGI
- MODULARITA' & VERSATILITA'
- PRECISIONI  $\pm 0,02$  mm
- RIGIDITA' & SICUREZZA
- DESIGN COMPATTO E MANEGGEVOLEZZA

Si rimanda a quanto esposto a pag. 1.4 e 1.5

(morse serie STANDARD)

### TECHNICAL FEATURES and ADVANTAGES

- NO WEAR
- QUICK CLAMPING
- MODULARITY & VERSATILITY
- HIGHEST ACCURACIES  $\pm 0,02$  mm
- RIGIDITY & SAFETY
- SPACE SAVING DESIGN & HANDY

See pag. 1.4 and 1.5 (STANDARD series vises)

### 1 RAPIDITA' DEI SERRAGGI

Grazie allo scorrimento del gruppo di serraggio nella guida della base (a cremagliera) fino in prossimità del pezzo da lavorare dove si adatterà automaticamente alla nicchia più vicina. L'operazione di serraggio si conclude agendo sulla vite di bloccaggio. Oltre a quello manuale meccanico, sono disponibili 4 ulteriori sistemi di serraggio intercambiabili e indipendenti:

1 - Idraulici / 2 - Pneumatici / 3 - Idraulici manuali / 4 - Idraulici elettrici.  
L'operazione è in termini di secondi.

### 1 QUICK CLAMPING

Thanks to the clamping device sliding in the vise base slide (compact rack type) till the proximity of the workpiece. The clamping is completed with the main screw. Besides the manual mechanic system, 4 further interchangeable and independent clamping systems are available:

1- Hydraulic / 2- Pneumatic / 3- Manual hydraulic / 4- Electrical hydraulic.  
The change needs only few seconds.

### 2 GANASCE FISSE RIPOSIZIONABILI

La ganascia fissa hanno la possibilità di essere posizionate sia con piastrine all'interno della base (come nelle foto), sia con piastrine che fuoriescono dalla base in modo da poter serrare anche particolari posizionati sul piano della tavola della macchina

### 2 FIXED JAWS with DOUBLE POSITIONS

Fixed jaw have the possibility to be positioned both with jaw plates inside the vise base (as shown in the picture) and with jaw plates externally from the vise base in order to be able to clamp even workpieces positioned on the machine table directly.

Art. 102

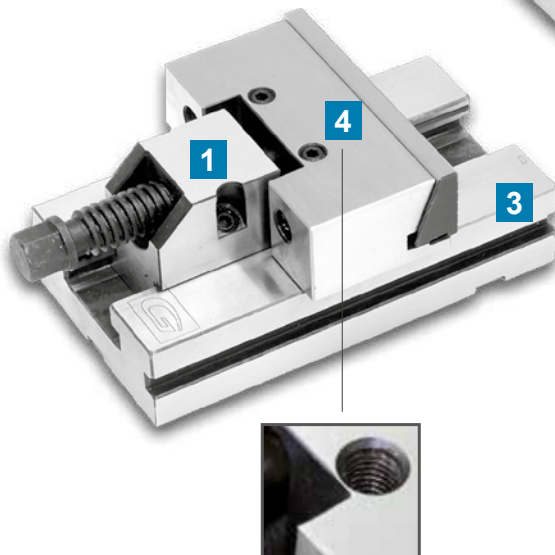

Art. 104

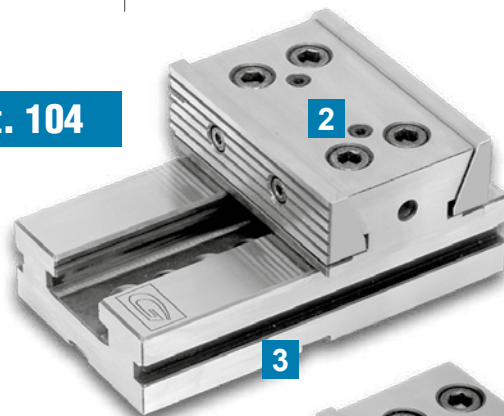

Art. 103

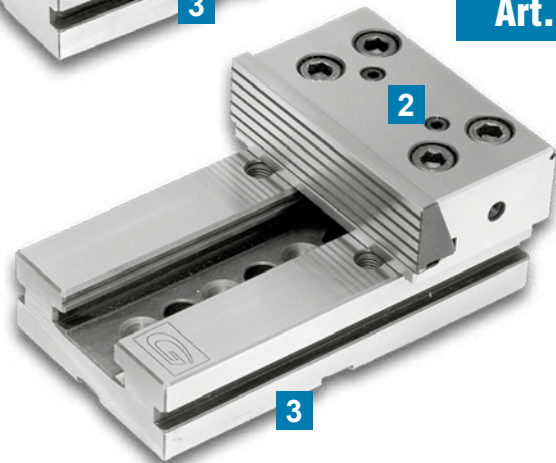

### 3 BASE VERSATILE

Slittone base (per Art.103 e 104) o elemento di prolunga (per Art.102) sempre previsti con chiavette di posizionamento longitudinali e trasversali per allineamento agli assi della macchina. Inoltre per le ganasce fisse sono sempre previsti 2 differenti posizionamenti per permettere alle stesse anche la possibilità di serrare pezzi direttamente appoggiati sul piano / tavola della macchina (vedi immagini pag. 3.6, 3.7)

### 3 BASE VERSATILITY

Vise bases (for Art. 102 and 104) or base extensions (for Art. 102) are always built with longitudinal and cross keyways in order to be aligned with the machine axis. Furthermore fixed jaws have always 2 different positions in order to be able to clamp even workpieces positioned on the machine table directly (see images on pages 3.6, 3.7).

### 4 FORI GANASCIA PER APPLICAZIONI SPECIALI

Quattro fori filettati supplementari sopra le ganasce danno la possibilità di installare ganasce sovrapposibili per applicazioni speciali.

### 4 JAW HOLES FOR SPECIAL APPLICATIONS

4 extra tapped holes over the jaws for special Gerardi stack type jaw application

## ESEMPI APPLICATIVI CON UTILIZZO ELEMENTI MODULARI APPLICATION EXAMPLES USING MODULAR ELEMENTS

3

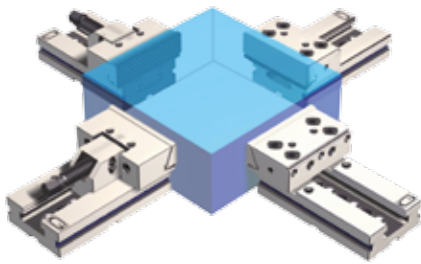

Esempio n°1 - Example #1

Particolari di grosse dimensioni posizionati su tavola macchina  
Huge workpieces clamped directly on the machine table

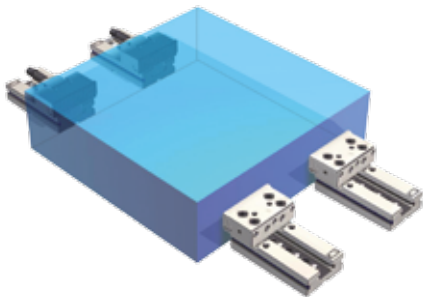
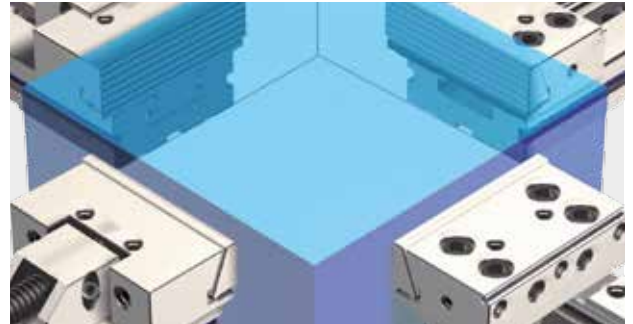

Esempio n°2 - Example #2

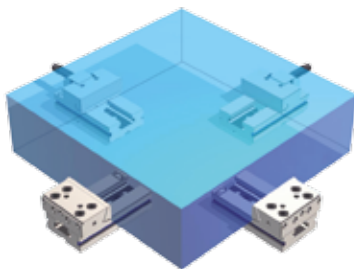
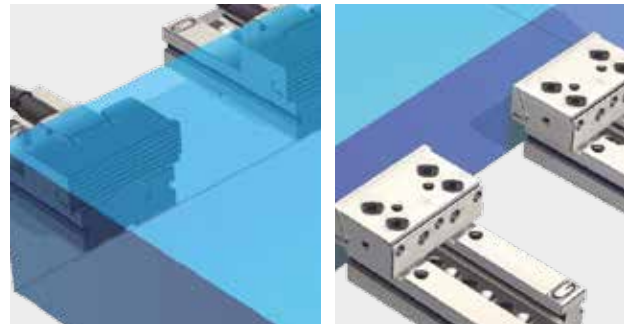

Esempio n°1 - Example #1

Particolari di medie dimensioni posizionati sugli elementi modulari.  
Medium size workpieces clamped on the vise sections

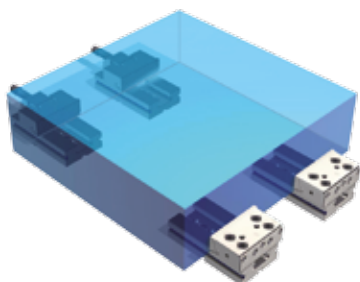

Esempio n°2 - Example #2



# ESEMPI APPLICATIVI CON UTILIZZO ELEMENTI MODULARI

## APPLICATION EXAMPLES USING MODULAR ELEMENTS

### Art. 1 + Art. 51

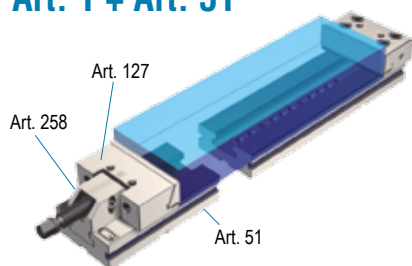

Esempio n°1 - Example #1

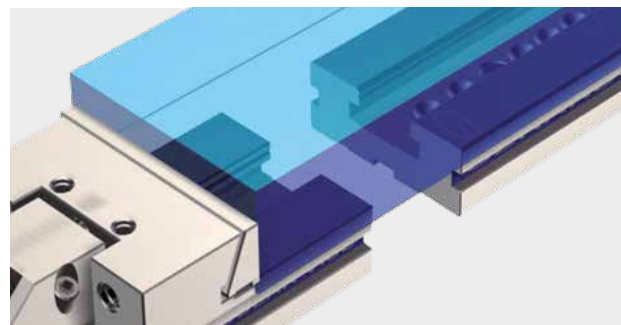

Per realizzare una stazione mobile è sufficiente sfilare dalla morsa Art.1 il gruppo di bloccaggio Art.258 + la ganaschia mobile Art.127 ed inserirli in un elemento di prolunga Art.51.  
In order to get a movable vise section it is enough to remove from vise Art.1 the blocking device Art.258 + the movable jaw Art.127 and to assemble them on an extension base Art.51

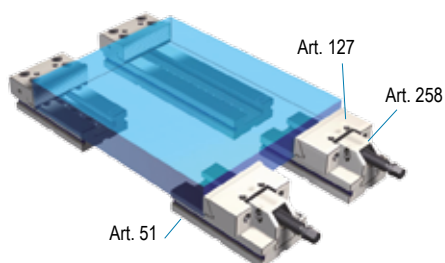

Esempio n°2 - Example #2

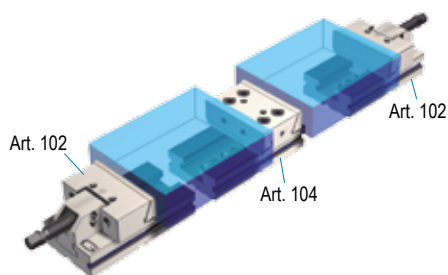
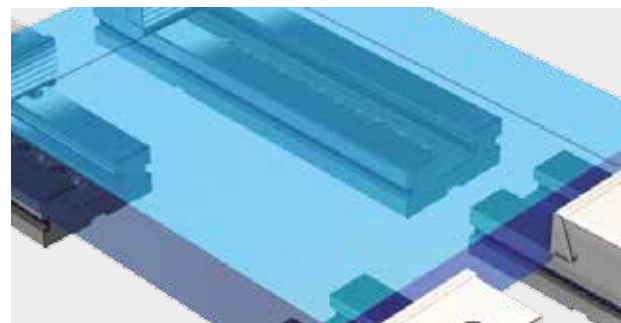

Elemento modulare fisso doppio (Art. 104) + 2 elementi modulari mobili (Art. 102)  
Double fixed vise section (Art. 104) + 2 movable vises sections (Art. 102)

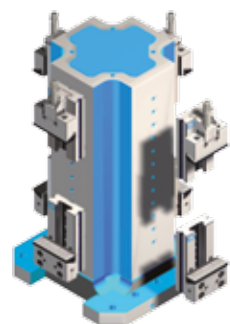
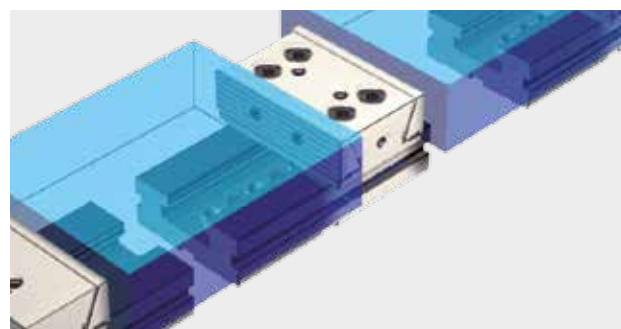

Elementi modulari montati su cubo a croce Art. 57  
Modular elements assembled on cross cube type Art. 57

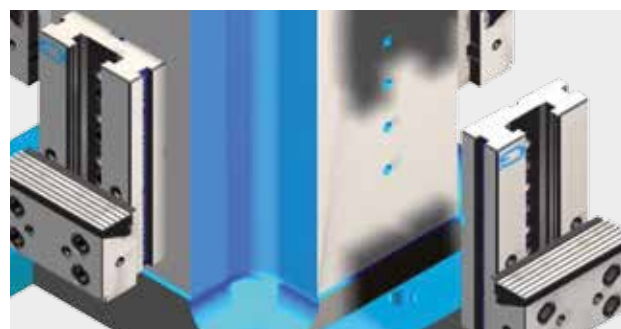

Tipo (grandezza) morsa / Vise (type) size

**Art. 102**

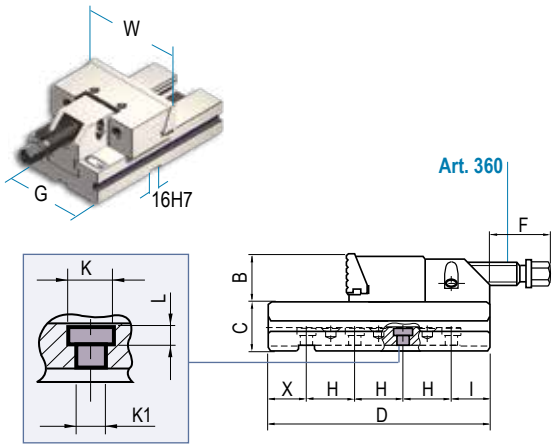
 Blocco tenditore completo di base.  
 Movable jaw section and base assy.

M = numero fori / M = holes number

	1	2	3	4	5	6
kN	16 kN	25 kN	30 kN	30 kN	40 kN	40 kN
W	100	125	150	175	200	300
B	30	40	50	60	65	80
C	35	40	50	58	70	78
D	140	160	230	240	300	350
F	55	83	82	62	92	70
G	75	95	125	145	170	195
H	40	40	50	50	100	100
I	29	39	40	82,5	50	83
K1 Ø	6,5	8,5	13	13	17	17
K Ø	10,5	13,5	19	19	26	26
L	4,5	5,5	8,5	8,5	17	17
X	31	41	40	57,5	50	67
kg	3,4	6,3	14,2	20,8	35	60
M	3	3	4	3	5	5
Cod.	2.10.21000	2.10.22000	2.10.23000	2.10.24000	2.10.25000	2.10.26000

 Disponibile anche versione **Art.112** con piastre piane - Also available **Art.112** version with straight plate jaws

**Art. 103**

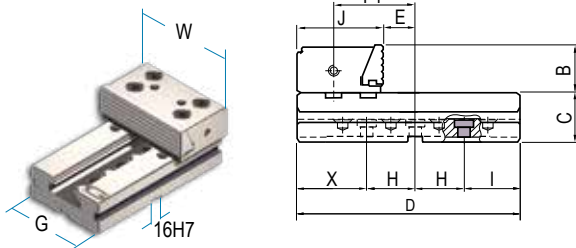
 Blocco fisso con ganascia fissa STD.  
 Fixed jaw section and base STD.

M = numero fori / M = holes number

J	77,9	77,9	89,4	96,9	113,4	120,4
E	33,6	33,6	33,6	33,6	33,6	33,6
F1	76	76	84,5	89	100	107
X	31	31	72,5	29	45	52
H	40	40	50	50	100	100
I	29	49	57,5	61	55	98
kg	3,3	5,8	12,6	17,8	29,8	50,5
M	3	3	3	4	5	5
Cod.	2.10.31000	2.10.32000	2.10.33000	2.10.34000	2.10.35000	2.10.36000

 Disponibile anche versione **Art.113** con piastre piane - Also available **Art.113** version with straight plate jaws

**Art. 104**

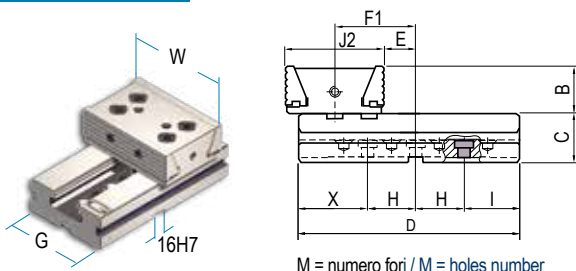
 Blocco fisso con ganascia doppia STD.  
 Fixed double jaw section and base STD.

M = numero fori / M = holes number

J2	84,8	84,8	101,8	110,8	132,8	146,8
E	33,6	33,6	33,6	33,6	33,6	33,6
kg	3,4	6	13,3	18,8	30	52,5
M	3	3	3	4	5	5
Cod.	2.10.41000	2.10.42000	2.10.43000	2.10.44000	2.10.45000	2.10.46000

 Disponibile anche versione **Art.114** con piastre piane - Also available **Art.114** version with straight plate jaws

Art. 102

Art. 103

Art. 104

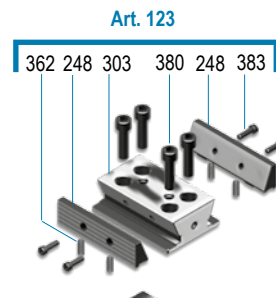
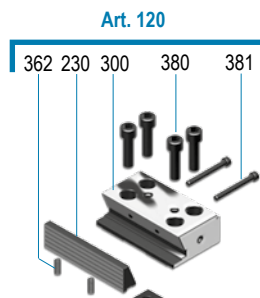
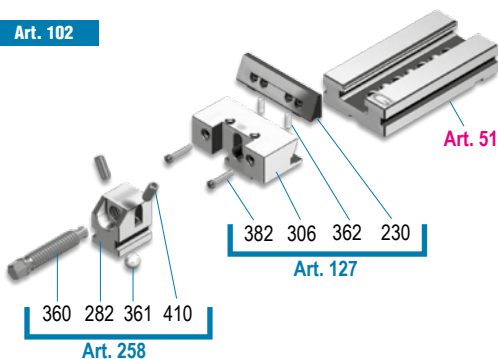
**Dotazione standard:**

■ 1 coppia di tasselli di posizionamento Art. 297

**Standard equipment:**

■ 1 pair of positioning key-nuts Art. 297

Art.	Pag.
44	3.12
44A	3.12
51	3.12
51A	3.12
120	4.8
123	4.8
127	4.8
230	4.9
248	4.9
258	4.32
282	4.32



Tipo (grandezza) morsa / Vise (type) size

**Art. 102A a reticolo / grid \***

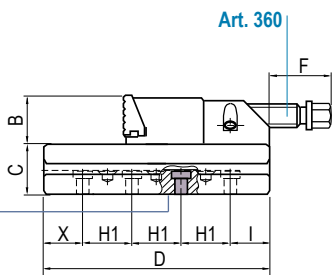
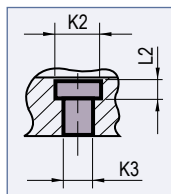
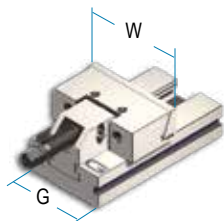
 Blocco tenditore completo di base per posizionamento con viti calibrate  
 Movable jaw section and base assy for positioning through shoulder screws

Foro calibrato / Calibrated hole

M = numero fori / M = holes number

	1 16 kN	2 25 kN	3 30 kN	4 30 kN	5 40 kN	6 40 kN
W	100	125	150	175	200	300
B	30	40	50	60	65	80
C	35	40	50	58	70	78
D	140	160	230	240	300	350
F	55	83	82	62	92	70
G	75	95	125	145	170	195
H1	50	50	50	50	100	100
I	54	39	40	57,5	69	83
K2 Ø	25	25	25	25	25	25
K3 Ø	16 <sup>F7</sup>	16 <sup>F7</sup>	16 <sup>F7</sup>	16 <sup>F7</sup>	16 <sup>F7</sup>	16 <sup>F7</sup>
L2	8	8	10	10	10	10
X	36	21	40	32,5	31	67
kg	3,4	6,3	14,2	20,8	35	60
M	2	3	4	4	3	3
Cod.	2.10.2A100	2.10.2A200	2.10.2A300	2.10.2A400	2.10.2A500	2.10.2A600

**Art. 103A a reticolo / grid \***

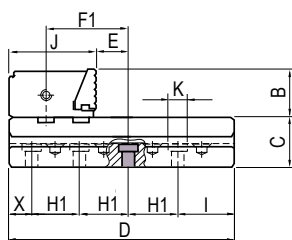
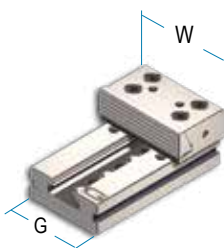
 Blocco fisso con ganascia fissa per posizionamento con viti calibrate  
 Fixed jaw section and base for positioning through shoulder screws

M = numero fori / M = holes number

J	77,9	77,9	89,4	96,9	113,4	120,4
E	33,6	33,6	33,6	33,6	33,6	33,6
F1	76	76	84,5	89	100	107
X	61	21	72,5	29	45	52
H1	50	50	50	50	100	100
I	29	49	57,5	61	55	98
kg	3,3	5,8	12,6	17,8	29,8	50,5
M	2	2	3	4	3	3
Cod.	2.10.3A100	2.10.3A200	2.10.3A300	2.10.3A400	2.10.3A500	2.10.3A600

**Art. 104A a reticolo / grid \***

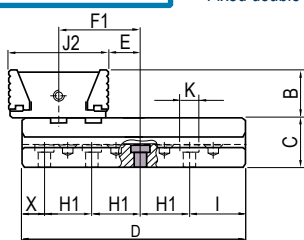
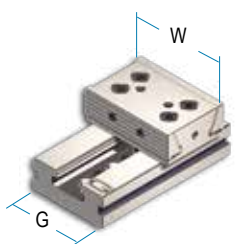
 Blocco fisso con ganascia doppia per posizionamento con viti calibrate  
 Fixed double jaw section and base for positioning through shoulder screws

M = numero fori / M = holes number

J2	84,8	84,8	101,8	110,8	132,8	146,8
E	33,6	33,6	33,6	33,6	33,6	33,6
kg	3,4	6	13,3	18,8	30	52,5
M	2	2	3	4	3	3
Cod.	2.10.4A100	2.10.4A200	2.10.4A300	2.10.4A400	2.10.4A500	2.10.4A600

Art.	Pag.
300	4.25
303	4.25
306	4.25
360	4.32
361	4.32
362	4.24
380	4.24
381	4.24
383	4.24
410	4.32
-	

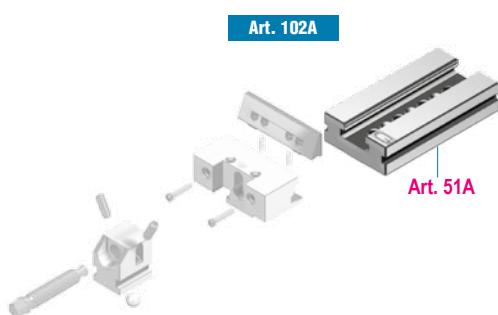

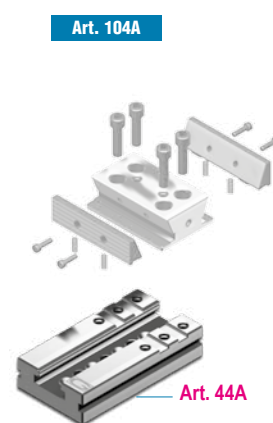
 Senza alcuna dotazione  
 Without accessory equipment

 A richiesta: vite calibrata Art. 83 o 83B  
 On request: shoulder screw Art. 83 or 83B

\* Passo del reticolo = 50 mm - Vite calibrata Ø 16F7 Grid Pitch = 50 mm - Shoulder screw Ø 16F7

Tipo (grandezza) morsa / Vise (type) size

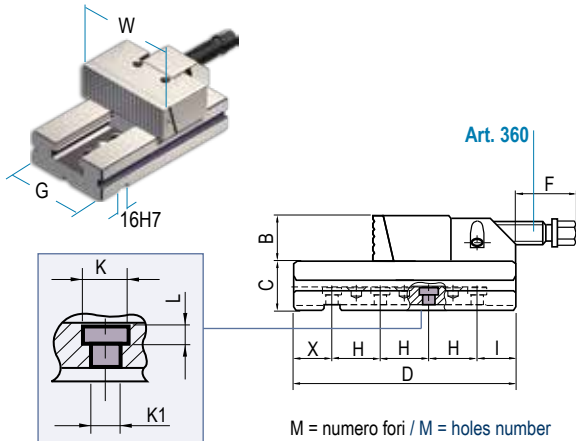
**Art. 102i**

 \* Blocco tenditore con ganaschia a cambio rapido. (Sistema a pettine)  
 \* Movable jaw section with quick change jaw plate. (Comb system)

M = numero fori / M = holes number

	1	2	3	4	5	6
kN	16 kN	25 kN	30 kN	30 kN	40 kN	40 kN
W	96	121	146	171	196	296
B	28	38	48	58	63	78
C	35	40	50	58	70	78
D	140	160	230	240	300	350
F	55	83	82	62	92	70
G	75	95	125	145	170	195
H	40	40	50	50	100	100
I	29	39	40	82,5	69	83
K1 Ø	6,5	8,5	13	13	17	17
K Ø	10,5	13,5	19	19	26	26
L	4,5	5,5	8,5	8,5	17	17
X	31	41	40	57,5	31	67
kg	3,4	6,3	14,2	20,8	35	60
M	3	3	4	3	5	5
Cod.	3.10.2i100	3.10.2i200	3.10.2i300	3.10.2i400	3.10.2i500	3.10.2i600

\* Serraggi disassati lateralmente non possibili \* Offset lateral clamping not possible

**Art. 103i**

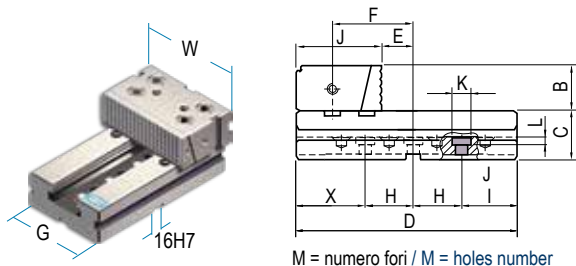
 \* Blocco fisso con ganaschia a cambio rapido. (Sistema a pettine)  
 \* Fixed jaw section with quick change jaw plate. (Comb system)

M = numero fori / M = holes number

J	77,9	77,9	89,4	96,9	113,4	120,4
E	33,6	33,6	33,6	33,6	33,6	33,6
F	76	76	84,5	89	100	107
X	31	31	72,5	29	45	52
H	40	40	50	50	100	100
I	29	49	57,5	61	55	98
kg	3,3	5,8	12,6	17,8	29,8	50,5
M	3	3	3	4	5	5
Cod.	3.10.3i100	3.10.3i200	3.10.3i300	3.10.3i400	3.10.3i500	3.10.3i600

\* Serraggi disassati lateralmente non possibili \* Offset lateral clamping not possible

**Art. 104i**

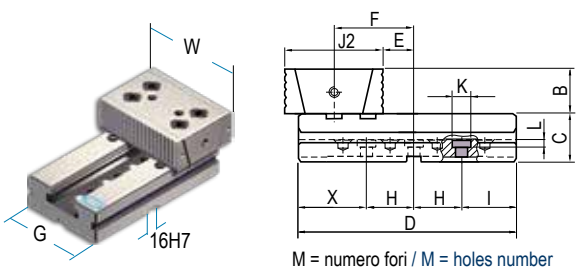
 \* Blocco fisso con ganaschia doppia a cambio rapido. (Sistema a pettine)  
 \* Fixed double-jaw section with quick change jaw plate. (Comb system)

M = numero fori / M = holes number

J2	84,8	84,8	101,8	110,8	132,8	146,8
E	33,6	33,6	33,6	33,6	33,6	33,6
kg	3,4	6	13,3	18,8	30	52,5
M	3	3	3	4	5	5
Cod.	3.10.4i100	3.10.4i200	3.10.4i300	3.10.4i400	3.10.4i500	3.10.4i600

\* Serraggi disassati lateralmente non possibili \* Offset lateral clamping not possible

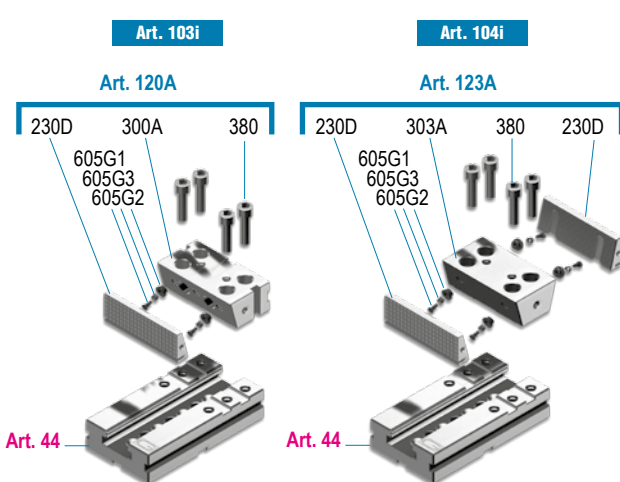
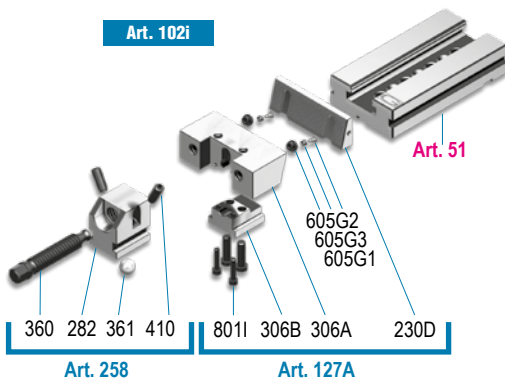

Art.	Pag.
44	3.12
44A	3.12
51	3.12
51A	3.12
120A	4.16
123A	4.16
127A	4.16
230D	4.17
258	4.32
282	4.32
300A	4.26

**Dotazione standard:**

■ 1 coppia di tasselli di posizionamento Art. 297 + 2 tappi Art. 291

**Standard equipment:**

■ 1 pair of positioning key-nuts Art. 297 + 2 insert Art. 291

Tipo (grandezza) morsa / Vise (type) size

**Art. 102Ai a reticolo / grid \***

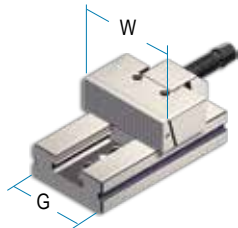
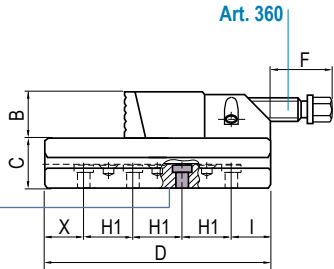
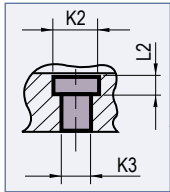
 \* Blocco tenditore con ganascia a cambio rapido. (Sistema a pettine)  
 \* Movable jaw section with quick change jaw plate. (Comb system)

**Art. 102Ai - 103Ai - 104Ai**  
 Basi per posizionamento con viti calibrate  
 Base assy for positioning through shoulder screws

Foro calibrato / Calibrated hole

M = numero fori / M = holes number

	1	2	3	4	5	6
kN	16 kN	25 kN	30 kN	30 kN	40 kN	40 kN
W	96	121	146	171	196	296
B	28	38	48	58	63	78
C	35	40	50	58	70	78
D	140	160	230	240	300	350
F	55	83	82	62	92	70
G	75	95	125	145	170	195
H1	50	50	50	50	100	100
I	54	39	40	57,5	69	83
K3 Ø	16 F7	16 F7	16 F7	16 F7	16 F7	16 F7
K2 Ø	25	25	25	25	25	25
L2	8	8	10	10	10	10
X	36	21	40	32,5	31	67
kg	3,4	6,3	14,2	20,8	35	60
M	2	3	4	4	3	3
Cod.	3.10.2Ai10	3.10.2Ai20	3.10.2Ai30	3.10.2Ai40	3.10.2Ai50	3.10.2Ai60

\* Serraggi disassati lateralmente non possibili \* Offset lateral clamping not possible

**Art. 103Ai a reticolo / grid \***

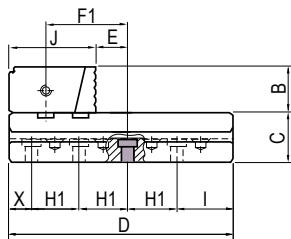
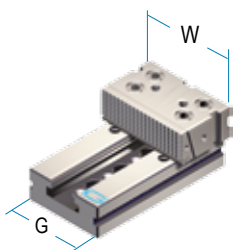
 \* Blocco fisso con ganascia a cambio rapido. (Sistema a pettine)  
 \* Fixed jaw section with quick change jaw plate. (Comb system)

M = numero fori / M = holes number

J	77,9	77,9	89,4	96,9	113,4	120,4
E	33,6	33,6	33,6	33,6	33,6	33,6
F1	76	76	84,5	89	100	107
X	61	21	72,5	29	45	52
H1	50	50	50	50	100	100
I	29	49	57,5	61	55	98
kg	3,3	5,8	12,6	17,8	29,8	50,5
M	2	2	3	4	3	3
Cod.	3.10.3Ai10	3.10.3Ai20	3.10.3Ai30	3.10.3Ai40	3.10.3Ai50	3.10.3Ai60

\* Serraggi disassati lateralmente non possibili \* Offset lateral clamping not possible

**Art. 104Ai a reticolo / grid \***

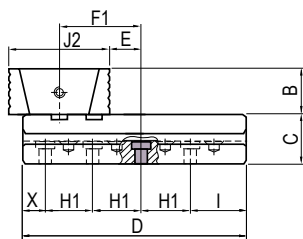
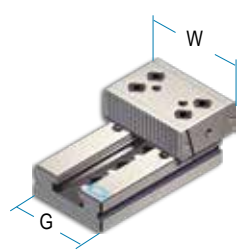
 \* Blocco fisso con ganascia doppia a cambio rapido. (Sistema a pettine)  
 \* Fixed double-jaw section with quick change jaw plate. (Comb system)

M = numero fori / M = holes number

J2	84,8	84,8	101,8	110,8	132,8	146,8
E	33,6	33,6	33,6	33,6	33,6	33,6
kg	3,4	6	13,3	18,8	30	52,5
M	2	2	3	4	3	3
Cod.	3.10.4Ai10	3.10.4Ai20	3.10.4Ai30	3.10.4Ai40	3.10.4Ai50	3.10.4Ai60

\* Serraggi disassati lateralmente non possibili \* Offset lateral clamping not possible

Art.	Pag.
303A	4.26
306A	4.26
306B	4.26
360	4.32
361	4.32
380	4.24
410	4.32
605G1	6.33
605G2	6.33
605G3	6.33
801I	5.61

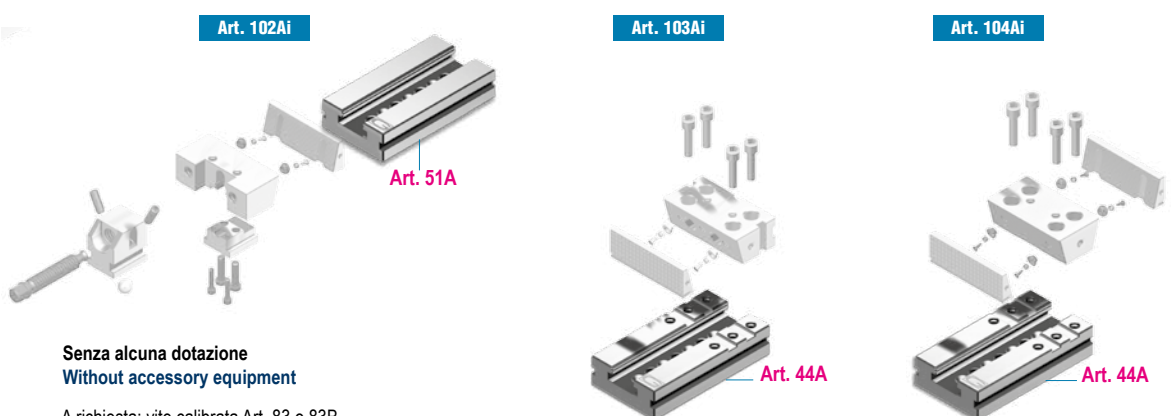

 Senza alcuna dotazione  
 Without accessory equipment

 A richiesta: vite calibrata Art. 83 o 83B  
 On request: calibrated screw Art. 83 or 83B

\* Passo del reticolo = 50 mm - Vite calibrata Ø 16F7 Grid Pitch = 50 mm - Shoulder screw Ø 16F7

**ELEMENTI MODULARI BASE / Supplemento Extra per ogni foro calibrato +78€**
**BASIC MODULAR UNITS / Extra supplement for each ground hole +78€**

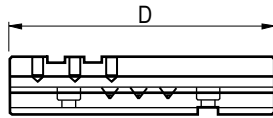
Tipo (grandezza) morsa / Vise (type) size

**Art. 44**

 Slittone base per ganascia fissa  
 Split base for fixed jaw

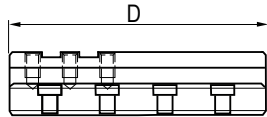
	1	2	3	4	5	6
G	75	95	125	145	170	195
D	140	160	230	240	300	350
kg	1.8	3.3	6.9	8	14.5	21.8
Cod.	1.80.14140	1.80.24160	1.80.34230	1.80.44250	1.80.54300	1.80.64351

**Art. 44A**

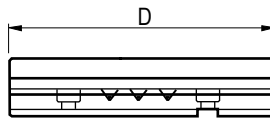
 Slittone base a reticolo (Passo 50 mm, Ø 16 per blocco fisso)  
 Split grid (50 mm) pitch, Ø 16 base for fixed section

D	140	160	230	240	300	350
kg	1.7	3.2	6.8	7.9	14.4	21.7
Cod.	3.44.A1000	3.44.A2000	3.44.A3000	3.44.A4000	3.44.A5000	3.44.A6000

**Art. 51**

 Elemento di prolunga base per  
 ganascia mobile  
 Base extension for  
 movable jaw

D	140	160	230	240	300	350
kg	2.1	3.4	8.2	11.5	20	30
Cod.	1.80.13140	1.80.23160	1.80.33230	1.80.43250	1.80.53300	1.80.63350

**Art. 51A**

 Elemento di prolunga base a reticolo (Passo 50 mm, Ø 16)  
 Grid (50 mm) pitch, Ø 16 base extension

Cod.	3.51.A1000	3.51.A2000	3.51.A3000	3.51.A4000	3.51.A5000	3.51.A6000
------	------------	------------	------------	------------	------------	------------

**ACCESSORI**  
**ACCESSORIES**

Tipo (grandezza) morsa / Vise (type) size

**Art. 358**

Barra di tensione / Tension bar

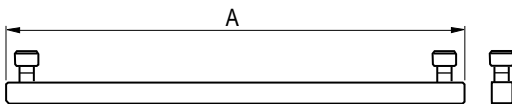

 Accessori per Art. 51 e 102  
 A richiesta altre larghezze senza variazione di prezzo

 Accessories for Art. 51 and 102  
 Other widths available on request without price change

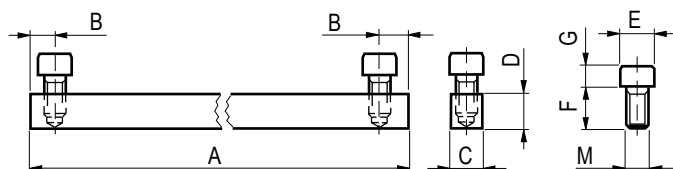
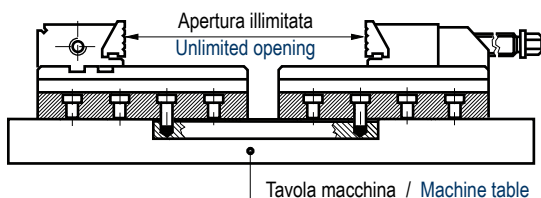
	1	2	3	4	5	6
A	320	320	400	400	500	500
B	11	11	18	18	20	20
C	10	10	15	15	20	20
D	20	20	25	25	25	25
M	M6	M8	M12	M12	M16	M16
E	9	12	18	18	24	24
F	15	15	20	20	30	30
G	6	8	12	12	16	16
kg	0.5	0.5	1.2	1.2	2	2
Cod.	3.35.81000	3.35.82000	3.35.83000	3.35.84000	3.35.85000	3.35.86000

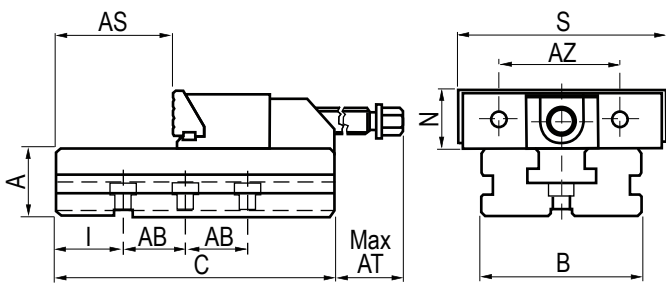

**Art. 102**



pos. 1

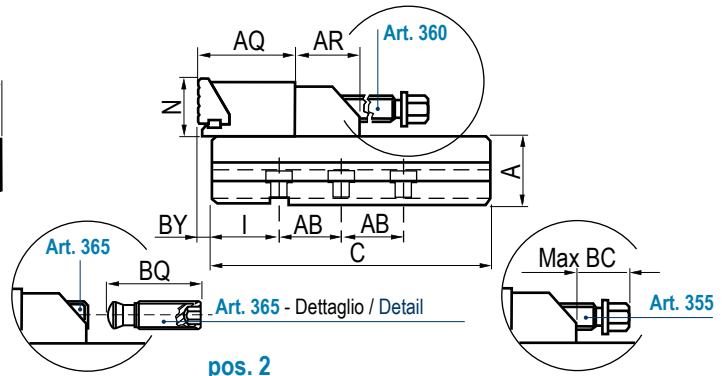

pos. 2

**Art. 103**

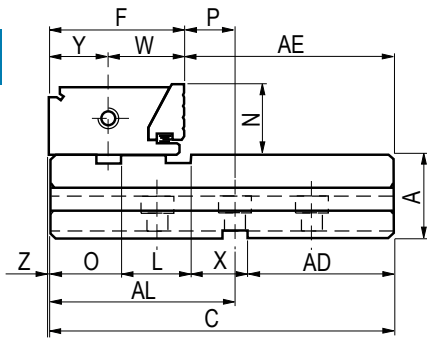

pos. 1

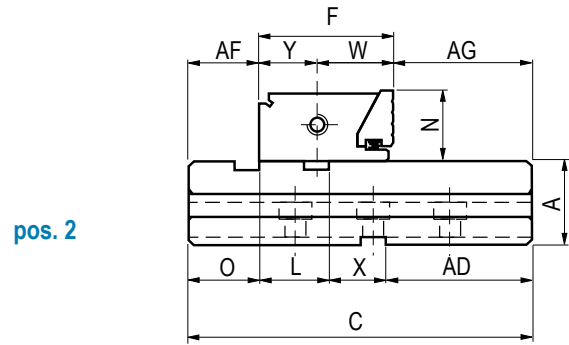

pos. 2

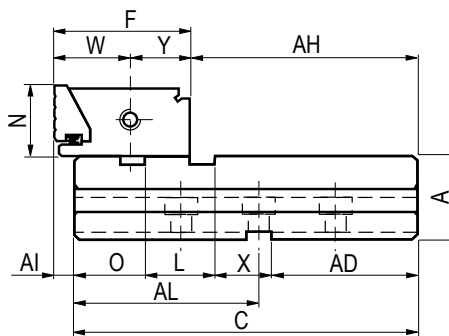

pos. 3

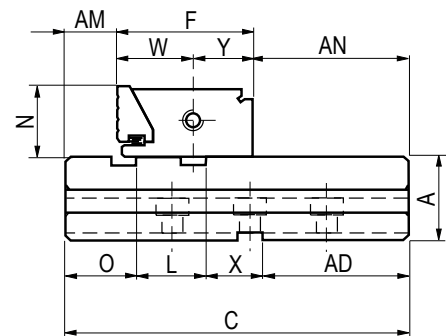

pos. 4

**Art. 104**

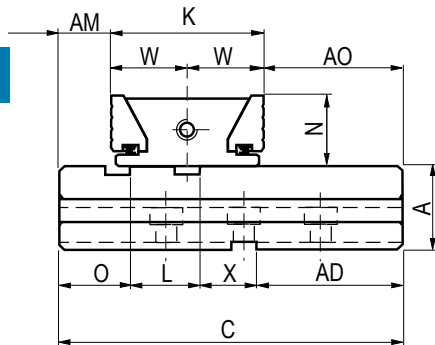

pos. 1

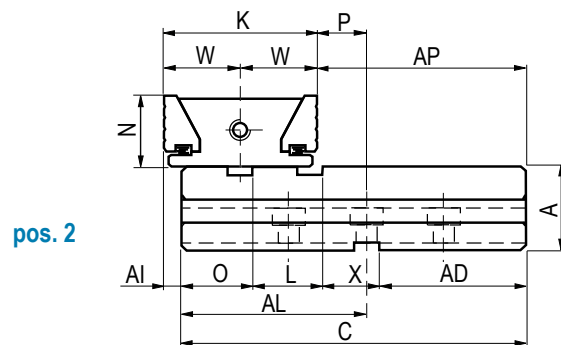

pos. 2

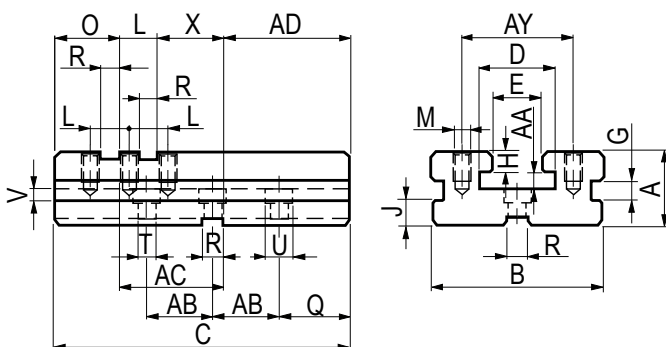

**Art. 44**

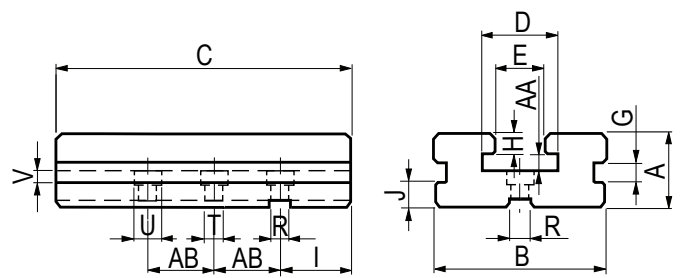

**Art. 51**

**Art. 102A**

pos. 1

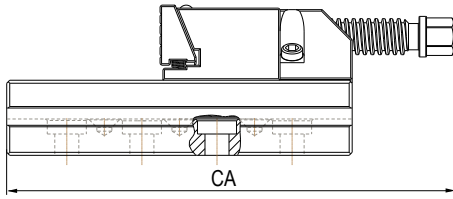

**Art. 102Ai**

pos. 2

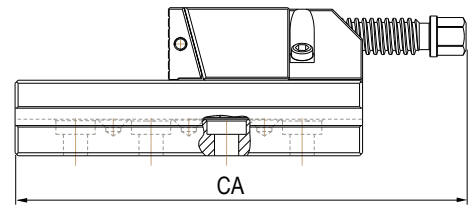

**Art. 103A**

pos. 1

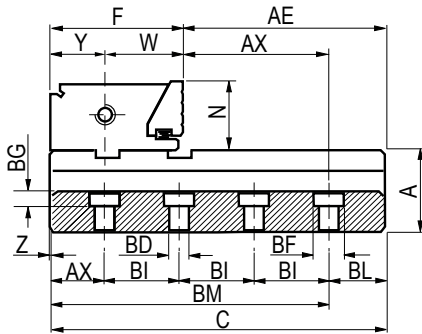

pos. 2

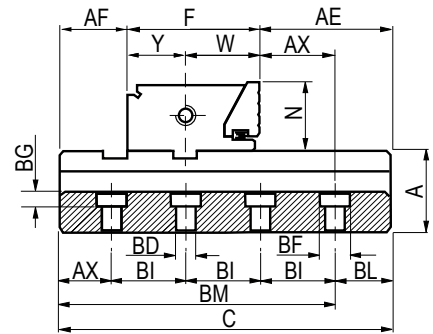

pos. 3

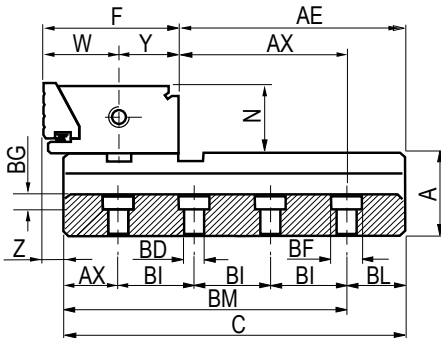

pos. 4

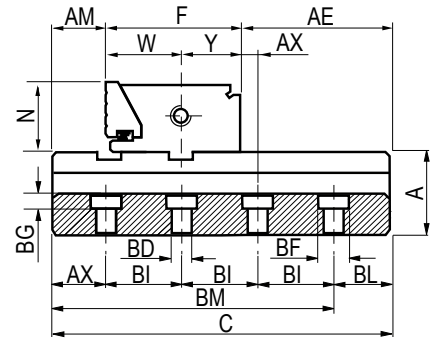

**Art. 104A**

pos. 1

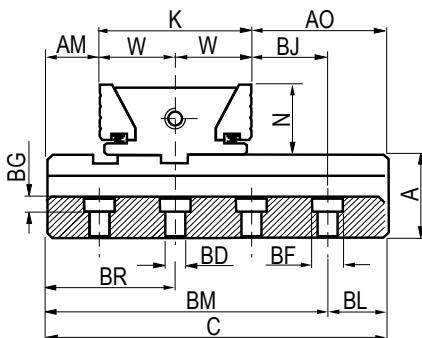

pos. 2

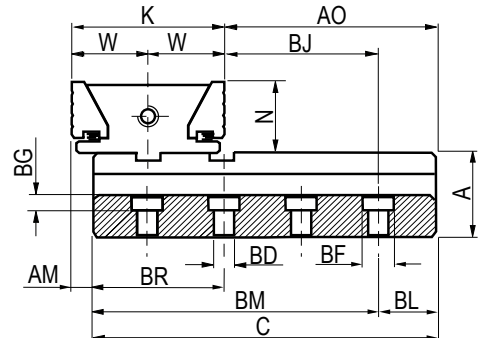

**Art. 44A**

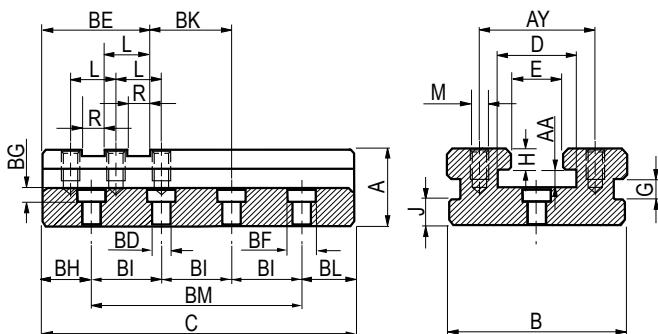

**Art. 51A**

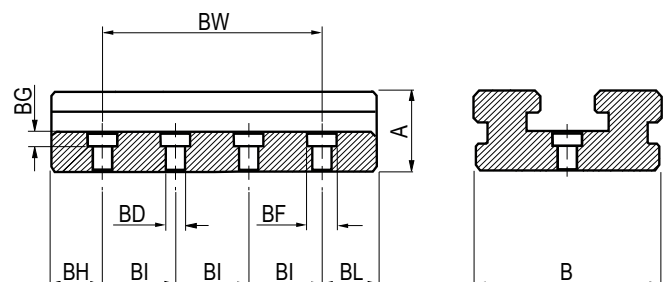

Tipo (grandezza) morsa / Vise (type) size

mm	1	2	3	4	5	6	Tolleranza Tolerance
A	35	40	50	58	70	78	- 0.02
B	75	95	125	145	170	195	- 0.02
C	140	160	230	240	300	350	
D	31	41	57	70	80	90	
E	21	28	41	51	61	71	+ 0.02
F	77.9	77.9	89.4	96.9	113.4	120.4	- 0.04
G	9.5	9.5	11.5	11.5	17.5	17.5	
H	10	10	13	15	20	20	- 0.02
I	31	41	40	57.5	31	67	
J	15	15	20	20	26	26	
K	84.8	84.8	101.8	101.8	132.8	146.8	- 0.04
L	32	32	36	36	44	44	- 0.02
M	M10	M12	M14	M16	M20	M20	
N	30	40	50	60	65	80	± 0.02
O	43	43	46	48	53	53	
P	33.6	33.6	33.6	33.6	33.6	33.6	± 0.02
Q	29	49	157.5	61	55	98	
R	16	16	16	16	16	16	H7
S	100	125	150	175	200	300	
T	6.5	8.5	13	13	17	17	
U	10.5	13.5	19	19	26	26	
V	4.5	5.5	8.5	8.5	17	17	
W	42.4	42.4	50.9	55.4	66.4	73.4	± 0.02
X	44	44	48.5	53	56	63	± 0.02
Y	35.5	35.5	35.5	41.5	47	47	± 0.02
Z	0.5	0.5	0.5	1.5	2	2	
AA	10	10	12	18	18	18	+ 0.04
AB	40	40	50	50	100	100	
AC	76	76	84.5	89	100	107	- 0.02
AD	21	41	99.5	103	147	190	
AE	62.6	82.6	141.6	144.6	188.6	231.6	
AF	31.5	31.5	35.5	35.5	42	42	
AG	30.6	50.6	105.1	108.6	144.6	187.6	
AH	69.5	89.5	153.5	158.5	208	258	
AI	7.4	7.4	12.9	15.4	21.4	28.4	
AJ	36	36	40.5	45	48	55	± 0.1
AK	80	80	120	120	160	240	± 0.01
	3 x Ø12	3 x Ø12	4 x Ø12	4 x Ø12	3 x Ø12	4 x Ø12	
AL	111	111	122.5	129	145	152	
AM	24.6	24.6	23.6	20.6	22.6	15.6	
AN	37.5	57.5	117.5	122.5	164	214	
AO	30.6	50.6	105.1	108.6	144.6	187.6	
AP	62.6	82.6	141.6	144.6	188.6	231.6	
AQ	50	60	80	90	100	120	
AR	32	51	48	68	78	94	
AS	28	49	102	82	122	136	
AT	55	68	82	62	92	70	
AU	45	38	47	27	52	45	

Tipo (grandezza) morsa / Vise (type) size

mm	1	2	3	4	5	6	Tolleranza Tolerance
AV	29	49	107.5	111	155	198	
AW	111	111	122.5	129	145	152	
AX	33.6	33.6	33.6	33.6	33.6	33.6	± 0.02
AY	50	62	88	100	120	133	
AZ	62	80	90	116	138	184	
BA							
BB	20	32	50	50	76	90	
BC	45	38	47	32	52	55	
BD	16	16	16	16	16	16	F7
BE	75	75	82	84	97	97	
BF	20.5	25	25	25	25	25	
BG	8	8	10	10	10	10	
BH	36	21	40	32.5	31	67	
BI	50	50	50	50	50	50	± 0.01
BJ	33.6	33.6	33.6	33.6	33.6	33.6	± 0.02
BK	36	36	40.5	45	48	55	± 0.01
BL	29	39	40	57.5	69	83	
BM	111	121	190	182.5	231	267	
BN	320	320	400	400	500	500	
BO	11	11	18	18	20	20	
BP	24.6	24.6	23.1	20.6	22.6	15.6	
BQ	35	35	38	40	45	45	
BR	67	67	74	76	89	89	
BS	12	12	12	12	12	12	F7
BT	20	20	20	20	20	20	
BU	8	8	8	8	8	8	
BV	31	31	42.5	49	65	72	
BW	100	100	150	150	200	200	± 0.01
	3 x Ø16	3 x Ø16	4 x Ø16	4 x Ø16	3 x Ø16	3 x Ø16	
BX	10	10	15	15	20	20	
BY	10	10	15	20	25	30	
BZ	40	40	40	40	40	40	± 0.01
CA	195	228	312	302	392	420	
CB							
CC	20	20	25	25	25	25	
CD	M6	M8	M12	M12	M16	M16	
CE	9	12	18	18	24	24	
CF	15	15	20	20	30	30	
CG	4	5	12	12	16	16	

# DIAGRAMMI SERRAGGIO MECCANICO CON CHIAVE DINAMOMETRICA DIAGRAMS MECHANICAL CLAMPING WITH TORQUE WRENCH



## GRUPPI DI SERRAGGIO MECCANICI

( Art. 258 e similari )

I diagrammi seguenti consentono di determinare le forze di serraggio ottenibili con le morse di varia grandezza (da 1 a 6), in funzione del momento applicato

## MECHANICAL CLAMPING DEVICES

( Art. 258 and similar )

The following diagrams give the clamping force that can be obtained with each vise type (size 1 to 6) depending on the torque

3

### ELEMENTI MODULARI TIPO 1 MODULAR ELEMENTS TYPE 1

Vite M12 - Passo 1,75mm  
Screw M12 - Pitch 1,75mm

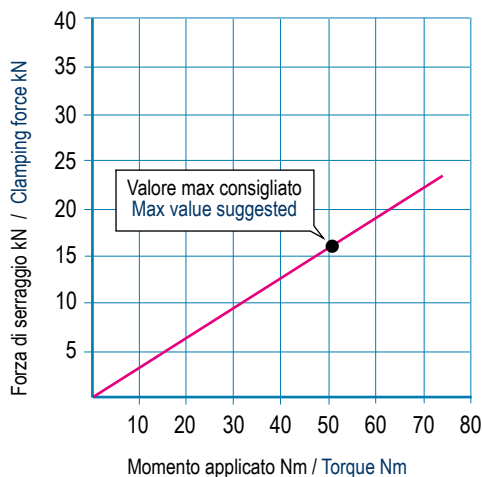

### ELEMENTI MODULARI TIPO 2 MODULAR ELEMENTS TYPE 2

Vite TPN18 - Passo 4mm  
Screw TPN18 - Pitch 4mm

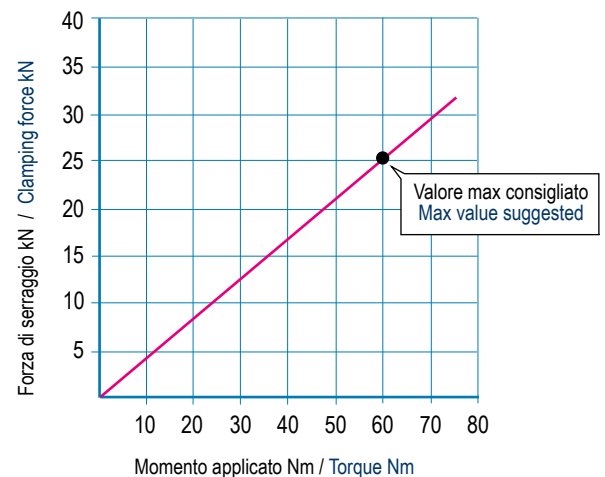

### ELEMENTI MODULARI TIPO 3-4 MODULAR ELEMENTS TYPE 3-4

Vite TPN24 - Passo 5mm  
Screw TPN24 - Pitch 5mm

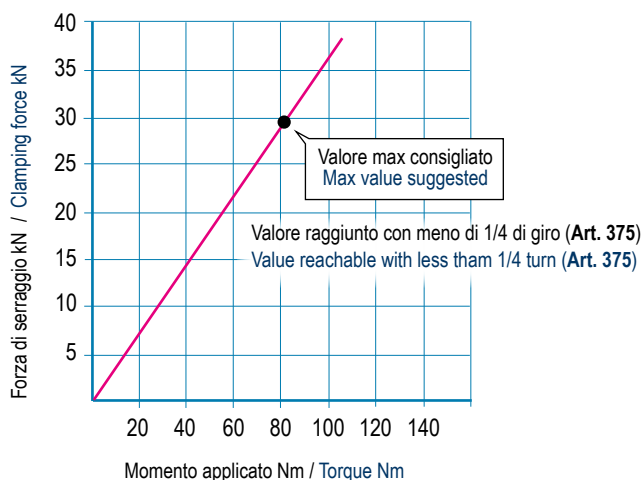

### ELEMENTI MODULARI TIPO 5-6 MODULAR ELEMENTS TYPE 5-6

Vite TPN30 - Passo 5mm  
Screw TPN30 - Pitch 5mm

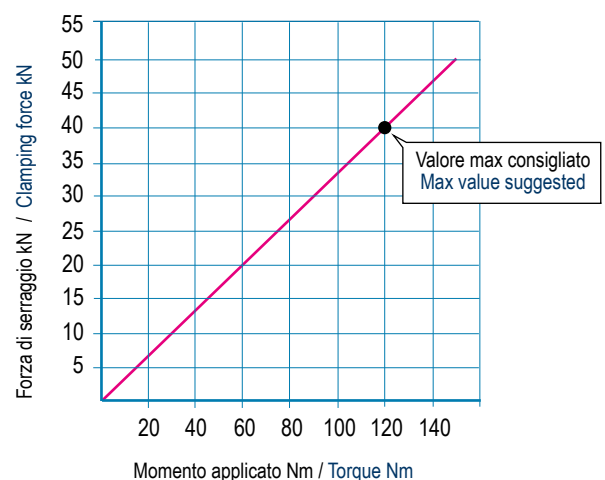

NB: Alcuni fattori, come la lubrificazione, lo staffaggio, gli attriti ed altro, possono modificare i valori indicati fino a  $\pm 10\%$ .

Per un corretto utilizzo non superare i valori indicati nel grafico

Some factor as lubrication, clamping on the machine table, frictions and more can modify above values within a  $\pm 10\%$  range.

For optimum operation do not exceed chart values.