

# XL Series MORSE - VISES



# INDICE - INDEX

2











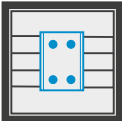
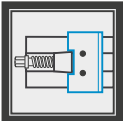
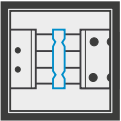



Art.	Pag 2.
20	6
21	8
22	10
24	12
25	14
30	16
32	18
34	20
35	22
20A	26
30A	28
42	30
42Z	30
212	6-8-12-16-20-26-28
213	10 - 18
217	6 - 8 - 16
218	10 - 14 - 18 - 22
230E	26 - 28
230B	26 - 28
230F	26 - 28
242G	6 - 8 - 16
243G	10 - 18
246	12 - 20
246G	12 - 20
247	14 - 22
247G	14 - 22
271	from 6 to 22
313	6 - 8 - 12 - 16 - 20
313R	10 - 14 - 18 - 22
391	from 6 to 28

Art.	Pag 2.

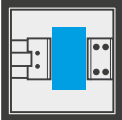
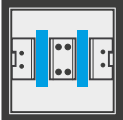
Art.	Pag 2.

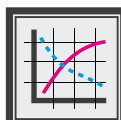

## SIMBOLOGIA DATI TECNICI TECHNICAL DATA ICONS

<p>GANASCE JAWS</p>		 Fissa Fixed	 Mobile Movable	 Intermedia Intermediate	 Fissa con piastra singola Fixed with single plate	 Fissa con piastra doppia Fixed with double plate
<p>PIASTRE GANASCE JAW PLATES</p>		 Discendente Pull down	 Piana Straight	 Cambio rapido manuale Quick manual change	 GRIP GRIP	 Inserti GRIP Inserti GRIP
<p>POSSIBILITÀ DI POSSIBILITY OF</p>		 Serraggio di 1 particolare Clamping only 1 piece	 Serraggio di 2 particolari Clamping 2 pieces	 Montaggio sul fianco o in serie Side mounting or gang operation	 Posizionamento cambio rapido Quick change & positioning	 Cubi-morsa Vise tower
<p>PAGINE PAGES</p>				 Accessori & Ricambi Accessories & Spare Parts	 Istruzioni corretto utilizzo Instruction for a proper use	 Diagrammi forze di serraggio Clamping force diagrams

# MORSE series XL

## XL VISES series

**La Morse XL prendono il nome dalle dimensioni Extra Large delle loro basi, molto più lunghe delle morse STD !**  
**XL vises derive their name from the Extra Large vise base dimension that is much longer than STD vises !**

Le morse **GERARDI** sono ormai considerate sinonimo di produzione ad alto livello tecnologico per l'accurata scelta dei materiali impiegati e per la precisione raggiunta anche nei minimi particolari. **Accuratamente rettificata** in ogni loro particolare ed ampiamente collaudate, consentono:

- ✓ una capacità di massimo rendimento della macchina / ✓ un forte carico di pressione / ✓ una maggior potenza di taglio,
- ✓ esclusione totale di vibrazioni / ✓ minor usura dell'utensile / ✓ una più precisa lavorazione

La costruzione con un sistema di elementi componibili consente le più svariate possibilità di impiego e combinazioni in caso di necessità.

Lo spazio sulla tavola della macchina a volte è limitato: le **morse XL** sono la risposta che vi permette di avere **due morse in una** perché si possono trasformare rapidamente da **morsa doppia a morsa singola di grande apertura**. La versione **XL doppia** permette la lavorazione di un numero maggiore di pezzi sfruttando al massimo la lunghezza della tavola della macchina utensile, ciò significa aumentare la produttività delle fasi attive del ciclo e di macchina stessa in quanto abbiamo:

- ✓ riduzione del numero dei carichi e conseguente risparmio dei tempi morti di fermo macchina / ✓ una minore incidenza (50%) dei tempi di cambio utensile / ✓ minori tempi di spostamento da una serie di pezzi a quella successiva / ✓ minore usura della macchina / ✓ operatore più libero dati i più lunghi tempi di ciclo complessivi.

In definitiva tutto ciò permette di ridurre al minimo i tempi morti di lavoro e quindi un **più rapido ammortamento degli impianti e delle stesse attrezzature**. La versione **XL singola** permette il serraggio di **pezzi di dimensioni insolite e di piastre** (con le appropriate ganasce). La notevole gamma di dimensioni e lunghezze delle basi garantisce il soddisfacimento delle più svariate necessità nonché una rigidità notevole dell'attrezzatura. Esiste la possibilità comunque di connettere due basi singole tramite un'apposita **ganascia fissa doppia di collegamento** per ottenere una morsa XL doppia da due basi standard (gr. 1) singole. A richiesta tutte le morse sono fornibili con tasselli di riferimento di varie grandezze o con fori calibrati.

**GERARDI** vises are manufactured under rigid quality control. Only the most suitable materials are used, and the accuracy of even the smallest components is assured. As a result of the high standard construction Gerardi vises can maintain their accuracy under the most severe operating conditions. Hardened and Ground steel construction throughout allowing you maximum machine performance with:

- ✓ bigger clamping power / ✓ bigger cutting performances / ✓ total exclusion of vibrations / ✓ lower tool wear
- ✓ higher precision during machinework

The modular design and the concept of interchangeability makes possible a wide variety of set up combination and solutions.

Space on the machine table is sometimes limited: **XL vises** enable to have **2 vises in 1** because they can quickly change **from double vise to single vise with very large opening**. Double XL vise allows to machine more workpieces using the total length of the machine tool, this means to increase productivity of the workpiece and of the machine itself because:

- ✓ reduction of total number of loading and unloading with consequence **save of dead times/interruptions** if machine is not working,
- ✓ reduction (50%) of total tool changing time,
- ✓ lower moving time from a series of pieces to another,
- ✓ lower machine wear,
- ✓ more time the **operator can walk away** to do other work because of longer total cycle times.

In conclusion all this allows to reduce to a minimum dead times/interruptions and consequently **faster payback period of machines and fixtures**.

**Single XL vise** allows to clamp **pieces of unusual dimensions and plates** (with the right jaws). The very wide range of widths and lengths of bases guarantees the satisfaction of the widest variety of works and a big rigidity of the fixture too. There is anyway the possibility to connect 2 single vises through a dedicated **double fixed connection jaw** to get one XL vise starting from 2 standard single bases. On request all vises can be supplied with key-nuts of different sizes or with ground holes.



### USURA INESISTENTE

Grazie all'accurata scelta dei materiali impiegati ed allo studio dimensionale computerizzato dei componenti. **Costruzione completamente in speciali leghe di acciaio** ad alta resistenza, normalizzato, cementato e temprato con **durezza 60 ±2 HRC**. Tutto ciò al fine di conferire massima rigidità, elevate prestazioni e usura inesistente. A riprova di tutto ciò assicuriamo **5 ANNI DI GARANZIA** su tutto il programma morse e organi meccanici in genere.

### NO WEAR

Thanks to the manufacturing with only the most suitable materials and to the structure of the vise components (developed using computer customised softwares and the experience gained during many years spent working on the specific field). **High alloyed quality resistance steel, case hardened HRC 60 ±2**, is used in manufacturing all the Gerardi vises and accessories in order to give maximum rigidity, high performances and no wear. As evidence we give **5 YEARS WARRANTY** on all the vises and mechanical components.



### DESIGN COMPATTO E MANEGGEVOLEZZA

La semplicità nonché la compattezza costruttiva consentono un'apertura notevole rispetto all'ingombro totale dell'attrezzatura. Inoltre lo stesso peso (solo 25 kg per una morsa da 150 mm di larghezza ganascia) è tale da consentire un facile trasferimento da una macchina all'altra.

### SPACE SAVING DESIGN & HANDY

The space saving design and solid construction allow a maximum blocking ratio to total overall dimension of the vise. Furthermore the weight (only 25 kg for a 150 mm jaw width vise) allows a simple moving from one machine to another.

**1-2 RAPIDITA' DEI SERRAGGI**

Grazie allo **scorrimento del gruppo di serraggio** nella guida della base (a cremagliera) fino in prossimità del pezzo da lavorare dove si adatterà automaticamente alla nicchia più vicina. L'operazione di serraggio si conclude agendo sulla vite di bloccaggio. Oltre a quello manuale meccanico, sono disponibili **4 ulteriori sistemi di serraggio** intercambiabili e indipendenti:

1 - Idraulici / 2 - Pneumatici / 3 - Idraulici manuali / 4 - Idraulici elettrici.  
L'operazione è in termini di secondi.

**1-2 QUICK CLAMPING**

Thanks to the **clamping device sliding in the vise base slide** (compact rack type) till the proximity of the workpiece. The clamping is completed with the main screw. Besides the manual mechanic system, **4 further** interchangeable and independent **clamping systems** are available:

1- Hydraulic / 2- Pneumatic / 3- Manual hydraulic / 4- Electrical hydraulic.  
The change needs only few seconds.

**3-4 PRECISIONI ± 0,02 mm**

Slittone base con tutte le superfici di scorrimento ed accoppiamento rettificata. L'allineamento agli assi della macchina avviene grazie alle **chiavette longitudinali e trasversali** (16H7) o fori di posizionamento (Ø16 mm F7), a richiesta, previsti nella parte inferiore della base di ciascuna morsa. Naturalmente tutto ciò consente oltre alle precisioni dichiarate **tempi di installazione ristrettissimi**.

**3-4 HIGHEST ACCURACIES ± 0,02 mm**

Solid vise base. Every sliding and coupling surface is ground. **Centesimal tolerances** are guaranteed by checking cycles with CNC measuring machine. The perfect alignment with the machine axis is given by **longitudinal and cross keyways** (16H7) upon specific request by positioning holes (Ø16 mm F7) on the bottom surface of the vise base. Of course this allows **minimum of set up times and gang operations**.

**Art. 30**

Morsa XL doppia apertura con ganascia mobile guidata monoblocco

Double opening XL vise with solid movable guided jaws

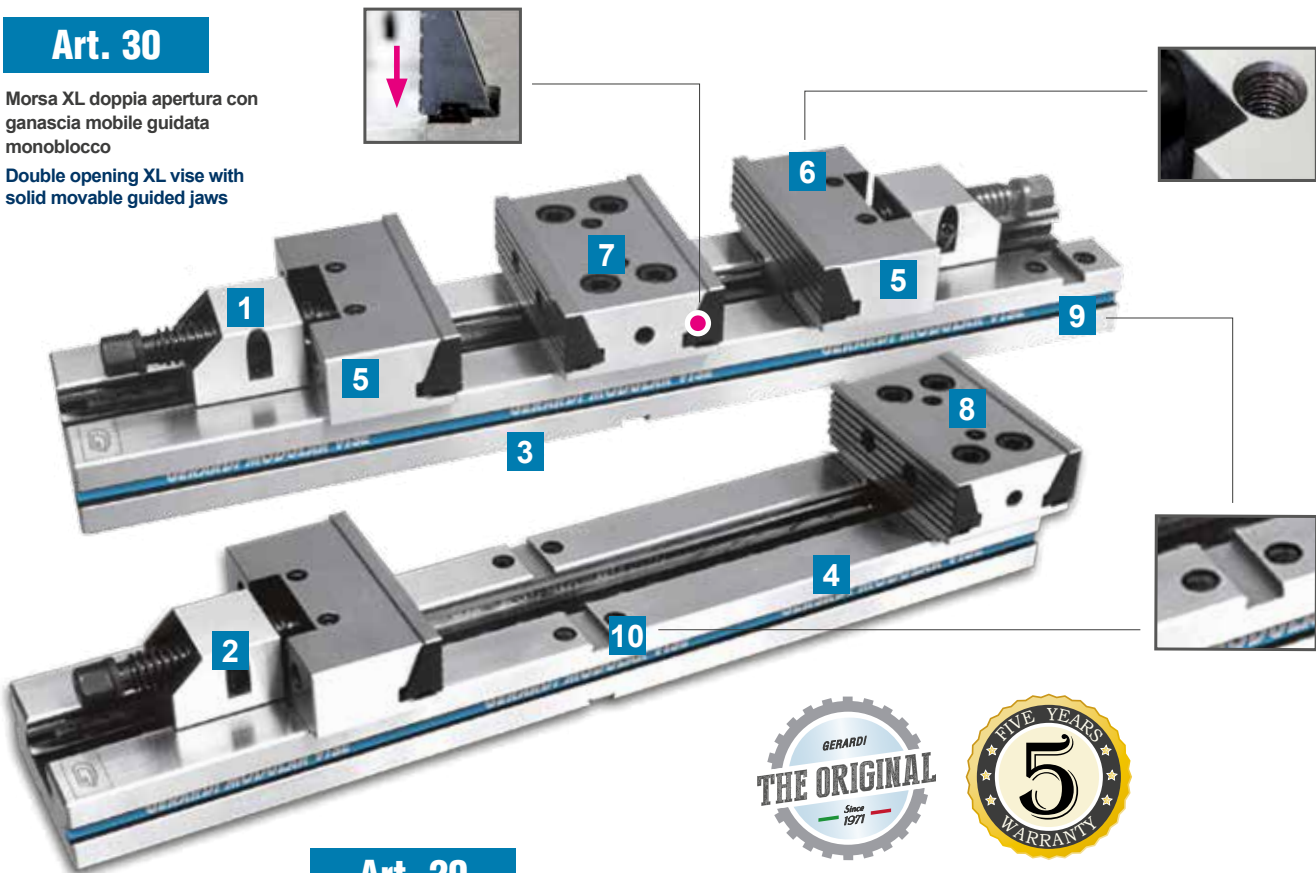

**Art. 20**



**5 SERRAGGI INDIPENDENTI**

Due Gruppi di serraggio indipendenti

**5 INDEPENDENT CLAMPINGS**

Two independent clamping devices

**6 FORI FILETTATI SOPRA LE GANASCE PER APPLICAZIONI SPECIALI**

Quattro fori filettati supplementari sopra le ganasce danno la possibilità di installare ganasce sovrapponibili per applicazioni speciali.

**6 THREADED HOLES ON THE TOP OF THE JAWS FOR SPECIAL APPLICATIONS**

4 extra tapped holes over the jaws for special Gerardi stack type jaw application

**7-8 GANASCIA FISSA DOPPIA**

Ganasce fisse doppie posizionabili sia al centro (per serraggi doppi), sia all'estremità della base (per serraggi singoli di particolari di grosse dimensioni).

**7-8 DOUBLE FIXED JAWS**

Double fixed jaw position both in the center of the vise base (for double clamping) and at the end (for single big workpieces Clamping).

**9-10 DUE SERIE DI CHIAVETTE**

Due serie di chiavette per due posizioni alternative delle ganasce fisse doppie.

**9-10 TWO DIFFERENT KEYWAYS**

Two different keyways for two alternatives positions of the double fixed jaw.

2

Tipo (grandezza) morsa / Vise (type) size	kN	1		2		3		4	
		16 kN	25 kN	30 kN	30 kN	30 kN	30 kN	30 kN	
Apertura massima / Maximum spread	A	290	320	360	460	400	500	600	700
	W	100	125	150			175		
	B	30	40	50			60		
	C	35	40	50			58		
	D	460	520	580	680	666	766	866	966
	G	75	95	125			145		
	kg	10	17	32	35	47	52	56	61
	Cod.	3.21.00000	3.22.10000	3.23.20000	3.23.30000	3.24.20000	3.24.30000	3.24.40000	3.24.50000

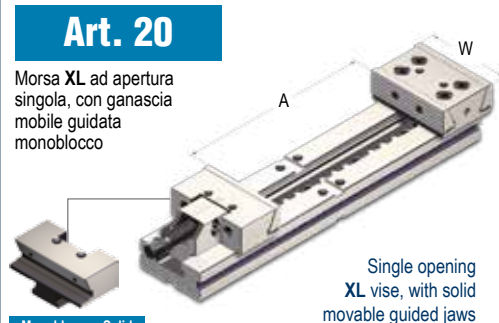

Monoblocco - Solid

**AMPLIA LE TUE APPLICAZIONI TRAMITE GLI ACCESSORI MODULARI !**

Art. 313	Cod.	4.31.31000	4.31.32000	4.31.33000	4.31.34000
Piastre magnetiche parallele piane Magnetic parallel plates	H	23	33	43	53

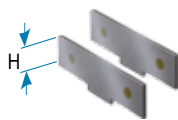

Art. 212	Cod.	1.21.21000	1.21.22000	1.21.23000	1.21.24000
Ganascia mobile intermedia (da usare con Art. 313) Intermediate movable jaw (to be used with Art. 313)	H				

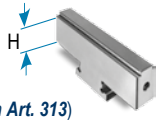

Art. 217	Cod.	2.21.71000	2.21.72000	2.21.73000	2.21.74000
Ganascia mobile prismatica Prismatic movable jaw					



Art. 242G	Cod.	1.24.2G100	1.24.2G200	1.24.2G300	1.24.2G400
Piastra ganascia con inserti GRIP Jaw plate with GRIP inserts					



Art. 271	Cod.	2.27.11000	2.27.12000	2.27.13000	2.27.14000
Supporto di serraggio con cilindro idraulico Clamping support with hydraulic cylinder					

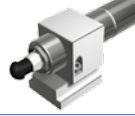

Art. 271	Cod.	4.39.11000	4.39.12000	4.39.13000	4.39.14000
Art. 271					

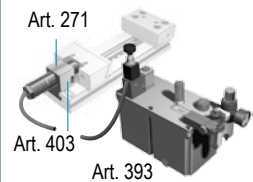

Art. 391	Cod.	4.39.21000	4.39.22000	4.39.23000	4.39.24000
CNC / CNC					

Art. 392	Cod.	4.39.21000	4.39.22000	4.39.23000	4.39.24000
Pneumatico / Air control					

 Servocomandi oleopneumatici (completi di 1 cilindro e supporto) per serraggi multipli **contemporanei** o **indipendenti**, da 2 a 6 morse. Vedi da pag. 4.36 a 4.47

**Dotazione standard:**

- 1 arresto laterale Art. 370
- 1 coppia di tasselli di posizionamento Art. 297  
(Standard per cava da 16 mm; altre dimensioni a richiesta senza variazione di prezzo)
- 1 chiave a pipa Art. 375 ■ 1 chiave a "T" Art. 376

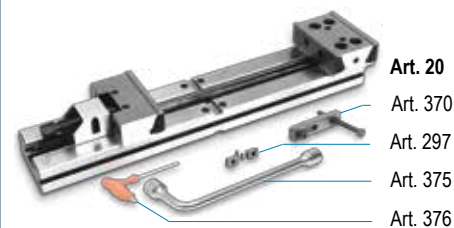
**Standard equipment:**

- 1 workshop Art. 370
- 1 pair of positioning key-nuts Art. 297  
(Standard for 16 mm slot. Other dimensions available on request without price change)
- 1 box wrench Art. 375 ■ 1 T-wrench Art. 376

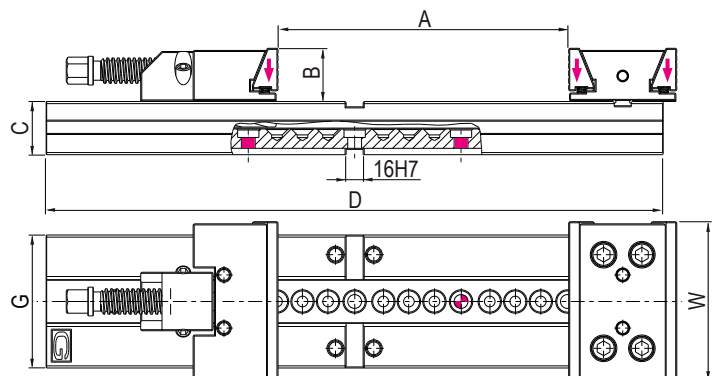
 Vedi gruppo 4 per gamma completa accessori  
 See group 4 for complete range of accessories



5 40 kN					6 40 kN						
500	600	700	800	900	500	600	700	800	900	1000	1100
		200						300			
		65						80			
		70						78			
805	905	1005	1105	1205	900	1000	1100	1200	1300	1400	1500
		170						195			
64	69	74	79	84	95	105	115	125	135	145	155
3.25.20000	3.25.30000	3.25.40000	3.25.50000	3.25.60000	3.26.20000	3.26.30000	3.26.40000	3.26.50000	3.26.60000	3.26.70000	3.26.80000

**UPGRADE YOUR VISE APPLICATIONS THROUGH MODULAR ACCESSORIES !**

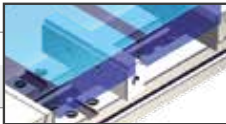
Art. 313	4.31.35000		4.31.36000
	53		68
Art. 212	1.21.25000		1.21.26000
Art. 217	2.21.75000		2.21.76000
Art. 242G	1.24.2G500		1.24.2G600
Art. 271	2.27.15000		2.27.16000
Art. 391	4.39.15000		4.39.16000
Art. 392	4.39.25000		4.39.26000

Pneumo-hydraulic servo units (complete of hydraulic cylinder + support) for multiple clamping *simultaneous* or *independent*, from 2 to 6 vises. See from page 4.36 to 4.47

**Art. 20**

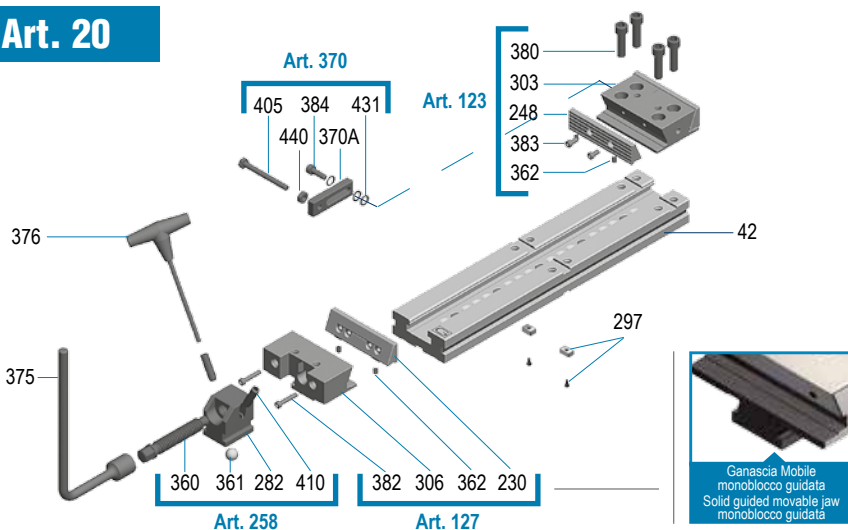

Art.	Pag.
42	2.30
230	4.9
248	4.9
282	4.32
297	4.31
303	4.25
306	4.25
360	4.32
361	4.32
362	4.24
370A	4.31

Art.	Pag.
375	4.31
376	4.31
380	4.24
382	4.24
383	4.24
384	4.24
405	4.31
410	4.32
431	4.24
440	4.24
-	-

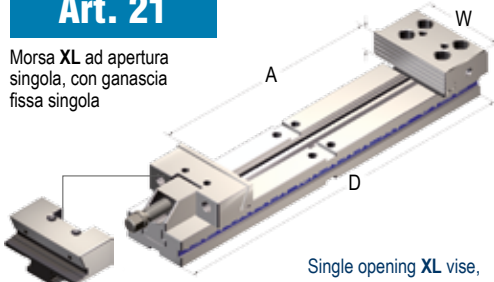

**2**

Tipo (grandezza) morsa / Vise (type) size	kN	1 16 kN	2 25 kN	3 30 kN		4 30 kN			
Apertura massima / Maximum spread	A	290	320	360	460	400	500	600	700
<b>Art. 21</b> Morsa XL ad apertura singola, con ganascia fissa singola 	W	100	125	150		175			
	B	30	40	50		60			
	C	35	40	50		58			
	D	460	520	580	680	666	766	866	966
	G	75	95	125		145			
kg		10	17	32	35	47	52	56	61
Cod.		2.21.00000	2.21.23200	2.21.33600	2.21.34600	2.21.44000	2.21.45000	2.21.46000	2.21.47000

Monoblocco - Solid

Single opening XL vise, with single fixed jaws

**AMPLIA LE TUE APPLICAZIONI TRAMITE GLI ACCESSORI MODULARI !**

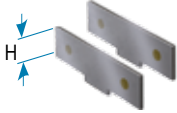
Art. 313	Cod.	4.31.31000	4.31.32000	4.31.33000	4.31.34000
Piastre magnetiche parallele piane Magnetic parallel plates 	H	23	33	43	53

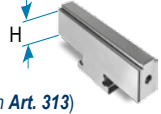
Art. 212	Cod.	1.21.21000	1.21.22000	1.21.23000	1.21.24000
Ganascia mobile intermedia (da usare con Art. 313) Intermediate movable jaw (to be used with Art. 313) 	H				

Art. 217	Cod.	2.21.71000	2.21.72000	2.21.73000	2.21.74000
Ganascia mobile prismatica Prismatic movable jaw 					

Art. 242G	Cod.	1.24.2G100	1.24.2G200	1.24.2G300	1.24.2G400
Piastra ganascia con inserti GRIP Jaw plate with GRIP inserts 					

Art. 271	Cod.	2.27.11000	2.27.12000	2.27.13000	2.27.14000
Supporto di serraggio con cilindro idraulico Clamping support with hydraulic cylinder 					

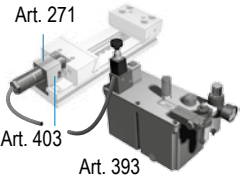
Art. 271	Cod.	4.39.11000	4.39.12000	4.39.13000	4.39.14000
Art. 271 	Art. 391				
	Art. 392				

CNC / CNC

Pneumatico / Air control

 Servocomandi oleopneumatici (completi di 1 cilindro e supporto) per serraggi multipli **contemporanei** o **indipendenti**, da 2 a 6 morse. Vedi da pag. 4.36 a 4.47

**Dotazione standard:**

- 1 arresto laterale Art. 370
- 1 coppia di tasselli di posizionamento Art. 297  
(Standard per cava da 16 mm; altre dimensioni a richiesta senza variazione di prezzo)
- 1 chiave a pipa Art. 375 ■ 1 chiave a "T" Art. 376

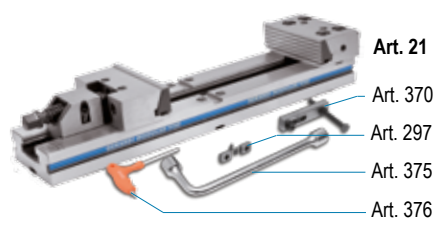
**Standard equipment:**



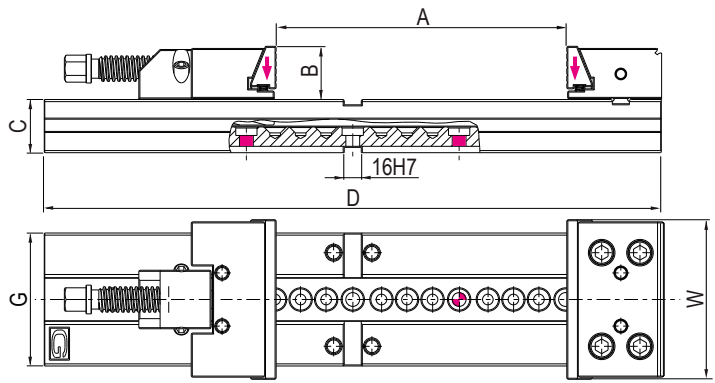

- 1 workshop Art. 370
- 1 pair of positioning key-nuts Art. 297  
(Standard for 16 mm slot. Other dimensions available on request without price change)
- 1 box wrench Art. 375 ■ 1 T-wrench Art. 376

 Vedi gruppo 4 per gamma completa accessori  
 See group 4 for complete range of accessories

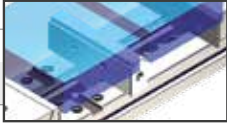

5 40 kN					6 40 kN						
500	600	700	800	900	500	600	700	800	900	1000	1100
		200						300			
		65						80			
		70						78			
805	905	1005	1105	1205	900	1000	1100	1200	1300	1400	1500
		170						195			
64	69	74	79	84	95	105	115	125	135	145	155
2.21.55000	2.21.56000	2.21.57000	2.21.58000	2.21.59000	2.21.65000	2.21.66000	2.21.67000	2.21.68000	2.21.69000	2.21.61000	2.21.61100

**UPGRADE YOUR VISE APPLICATIONS THROUGH MODULAR ACCESSORIES !**

Art. 313	4.31.35000		4.31.36000
	53		68
Art. 212	1.21.25000		1.21.26000
Art. 217	2.21.75000		2.21.76000
Art. 242G	1.24.2G500		1.24.2G600
Art. 271	2.27.15000		2.27.16000
Art. 391	4.39.15000		4.39.16000
Art. 392	4.39.25000		4.39.26000

Pneumo-hydraulic servo units (complete of hydraulic cylinder + support) for multiple clamping *simultaneous* or *independent*, from 2 to 6 vises. See from page 4.36 to 4.47

**Art. 21**

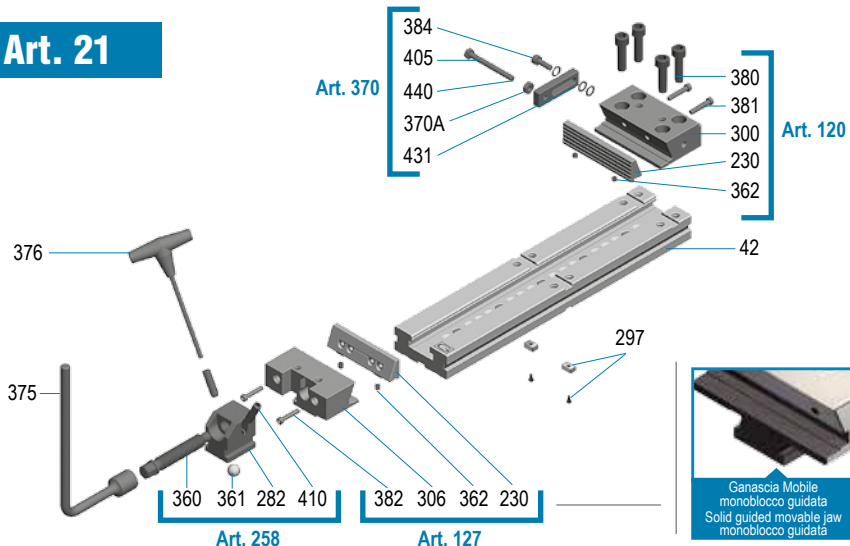

Art.	Pag.	Art.	Pag.
42	2.30	375	4.31
230	4.9	376	4.31
248	4.9	380	4.24
282	4.32	382	4.24
297	4.31	383	4.24
300	4.25	384	4.24
306	4.25	405	4.31
360	4.32	410	4.32
361	4.32	431	4.24
362	4.24	440	4.24
370A	4.31	-	-

2

Tipo (grandezza) morsa / Vise (type) size	kN	1		2		3		4	
		16 kN	25 kN	30 kN	30 kN	30 kN	30 kN	30 kN	30 kN
Apertura massima / Maximum spread	A	290	320	360	460	400	500	600	700
<b>Art. 22</b> Morsa XL ad apertura singola con ganasce ridotte rettificate. (Maggior Pressione)	W	75	95	125			145		
	B	30	40	50			60		
	C	35	40	50			58		
	D	460	520	580	680	666	766	866	966
	G	75	95	125			145		
	kg	9.4	15.8	29.8	32.8	44.8	49.8	54.8	59.8
	Cod.	3.21.00220	3.22.10220	3.23.20220	3.23.30220	3.24.20220	3.24.30220	3.24.40220	3.24.50220

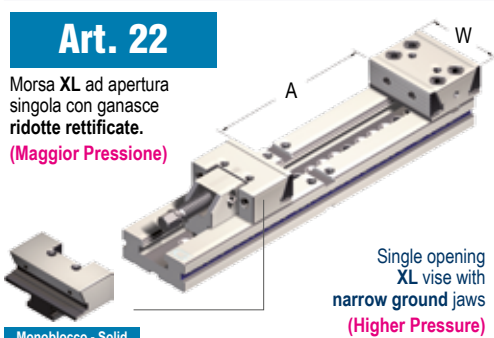

Monoblocco - Solid

**AMPLIA LE TUE APPLICAZIONI TRAMITE GLI ACCESSORI MODULARI !**

<b>Art. 313R</b> Piastrine magnetiche parallele piane Magnetic parallel plates	Cod.	4.31.3R100	4.31.3R200	4.31.3R300	4.31.3R400
	H	23	33	43	53

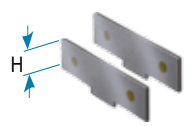

<b>Art. 213</b> Ganascia mobile intermedia (da usare con Art. 313R) Intermediate movable jaw (to be used with Art. 313R)	Cod.	1.21.31000	1.21.32000	1.21.33000	1.21.34000
	H				

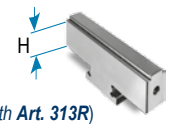

<b>Art. 218</b> Ganascia mobile prismatica Prismatic movable jaw	Cod.	2.21.81000	2.21.82000	2.21.83000	2.21.84000



<b>Art. 243G</b> <span style="color: red; font-weight: bold;">NEW!</span> Piastra ganascia ridotta con inserti GRIP Narrow width jaw plate with GRIP inserts	Cod.	1.24.3G100	1.24.3G200	1.24.3G300	1.24.3G400

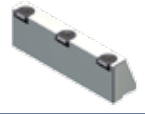

<b>Art. 271</b> Supporto di serraggio con cilindro idraulico Clamping support with hydraulic cylinder	Cod.	2.27.11000	2.27.12000	2.27.13000	2.27.14000

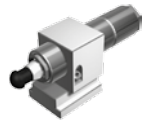

Art. 271	<b>Art. 391</b> CNC / CNC	Cod.	4.39.11000	4.39.12000	4.39.13000	4.39.14000
Art. 403	<b>Art. 392</b> Pneumatico / Air control	Cod.	4.39.21000	4.39.22000	4.39.23000	4.39.24000
Art. 393						

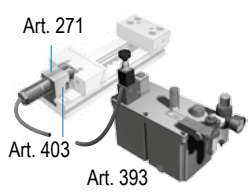

 Servocomandi oleopneumatici (completi di 1 cilindro e supporto) per serraggi multipli **contemporanei** o **indipendenti**, da 2 a 6 morse. Vedi da pag. 4.36 a 4.47

**Dotazione standard:**

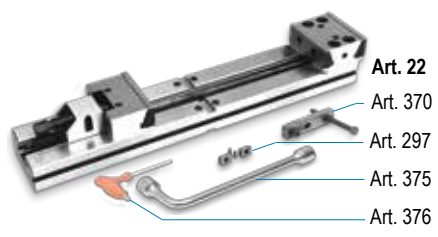
- 1 arresto laterale Art. 370
- 1 coppia di tasselli di posizionamento Art. 297  
(Standard per cava da 16 mm; altre dimensioni a richiesta senza variazione di prezzo)
- 1 chiave a pipa Art. 375 ■ 1 chiave a "T" Art. 376

**Standard equipment:**

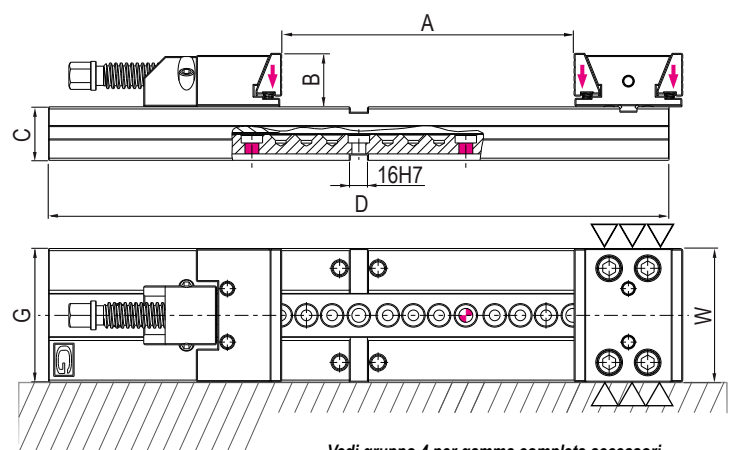
- 1 workstop Art. 370
- 1 pair of positioning key-nuts Art. 297  
(Standard for 16 mm slot. Other dimensions available on request without price change)
- 1 box wrench Art. 375 ■ 1 T-wrench Art. 376



 Vedi gruppo 4 per gamma completa accessori  
 See group 4 for complete range of accessories

5 40 kN					6 40 kN						
500	600	700	800	900	500	600	700	800	900	1000	1100
		170						195			
		65						80			
		70						78			
805	905	1005	1105	1205	900	1000	1100	1200	1300	1400	1500
		170						195			
82.5	88.5	96.5	103.5	110.5	116	129	139	149	159	169	179
3.25.20220	3.25.30220	3.25.40220	3.25.50220	3.25.60220	3.26.20220	3.26.30220	3.26.40220	3.26.50220	3.26.60220	3.26.70220	3.26.80220

**UPGRADE YOUR VISE APPLICATIONS THROUGH MODULAR ACCESSORIES !**

<b>Art. 313R</b>	4.31.3R500		4.31.3R600
	53		68
<b>Art. 213</b>	1.21.35000		1.21.36000
<b>Art. 218</b>	2.21.85000		2.21.86000
<b>Art. 243G</b>	1.24.3G500		1.24.3G600
<b>Art. 271</b>	2.27.15000		2.27.16000
<b>Art. 391</b>	4.39.15000		4.39.16000
<b>Art. 392</b>	4.39.25000		4.39.26000

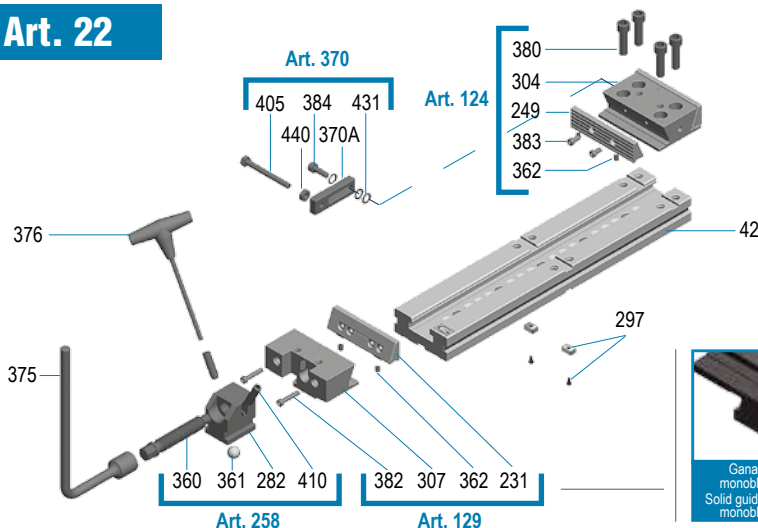
 Pneumo-hydraulic servo units (complete of hydraulic cylinder + support) for multiple clamping *simultaneous* or *independent*, from 2 to 6 vises. See from page 4.36 to 4.47

**Art. 22**

Art.	Pag.	Art.	Pag.
<b>42</b>	2.30	<b>375</b>	4.31
<b>231</b>	4.9	<b>376</b>	4.31
<b>249</b>	4.9	<b>380</b>	4.24
<b>282</b>	4.32	<b>382</b>	4.24
<b>297</b>	4.31	<b>383</b>	4.24
<b>304</b>	4.25	<b>384</b>	4.24
<b>307</b>	4.25	<b>405</b>	4.31
<b>360</b>	4.32	<b>410</b>	4.32
<b>361</b>	4.32	<b>431</b>	4.24
<b>362</b>	4.24	<b>440</b>	4.24
<b>370A</b>	4.31	-	-

2

Tipo (grandezza) morsa / Vise (type) size		1		2		3		4		
		16 kN		25 kN		30 kN		30 kN		
		kN		kN		kN		kN		
Apertura massima / Maximum spread		A	290	320	360	460	400	500	600	700
Art. 24		W	100	125	150			175		
Morsa XL con ganasce a piastre piane		B	30	40	50			60		
		C	35	40	50			58		
XL vise with straight-plate jaw		D	460	520	580	680	666	766	866	966
Monoblocco - Solid		G	75	95	125			145		
		kg	9.4	15.8	29.8	32.8	44.8	49.8	54.8	59.8
		Cod.	2.24.12900	2.24.23200	2.24.33600	2.24.34600	2.24.44000	2.24.45000	2.24.46000	2.24.47000

**AMPLIA LE TUE APPLICAZIONI TRAMITE GLI ACCESSORI MODULARI !**

Art. 313	Cod.		4.31.31000	4.31.32000	4.31.33000	4.31.34000
Piastre magnetiche parallele piane Magnetic parallel plates		H	23	33	43	53

Art. 212	Cod.		1.21.21000	1.21.22000	1.21.23000	1.21.24000
Ganascia mobile intermedia (da usare con Art. 313) Intermediate movable jaw (to be used with Art. 313)		H				

Art. 246	Cod.		1.65.16200	1.65.26200	1.65.36200	1.65.46200
Piastra piana in acciaio lavorabile Machinable steel straight jaw plate						

Art. 246G	Cod.		1.24.6G100	1.24.6G200	1.24.6G300	1.24.6G400
Piastra piana con inserti GRIP Straight jaw plate with GRIP inserts						

Art. 271	Cod.		2.27.11000	2.27.12000	2.27.13000	2.27.14000
Supporto di serraggio con cilindro idraulico Clamping support with hydraulic cylinder						

Art. 391	Cod.		4.39.11000	4.39.12000	4.39.13000	4.39.14000
CNC / CNC						

Art. 392	Cod.		4.39.21000	4.39.22000	4.39.23000	4.39.24000
Pneumatico / Air control						

 Servocomandi oleopneumatici (completi di 1 cilindro e supporto) per serraggi multipli **contemporanei** o **indipendenti**, da 2 a 6 morse. Vedi da pag. 4.36 a 4.47

- Dotazione standard:**
- 1 arresto laterale Art. 370
  - 1 coppia di tasselli di posizionamento Art. 297 (Standard per cava da 16 mm; altre dimensioni a richiesta senza variazione di prezzo)
  - 1 chiave a pipa Art. 375 ■ 1 chiave a "T" Art. 376

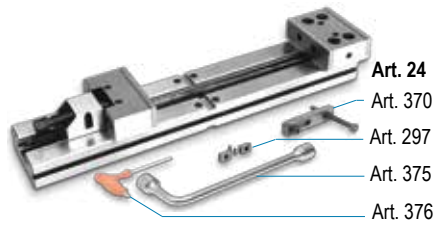



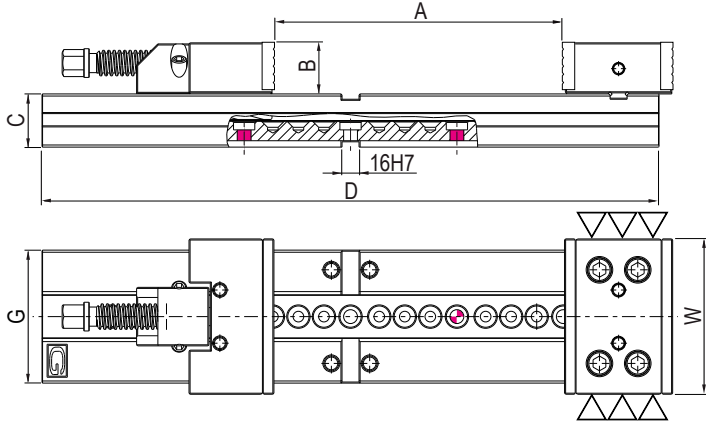

- Standard equipment:**
- 1 workstop Art. 370
  - 1 pair of positioning key-nuts Art. 297 (Standard for 16 mm slot. Other dimensions available on request without price change)
  - 1 box wrench Art. 375 ■ 1 T-wrench Art. 376

 Vedi gruppo 4 per gamma completa accessori  
 See group 4 for complete range of accessories

5 40 kN					6 40 kN						
500	600	700	800	900	500	600	700	800	900	1000	1100
		200						300			
		65						80			
		70						78			
805	905	1005	1105	1205	900	1000	1100	1200	1300	1400	1500
		170						195			
82.5	88.5	96.5	103.5	110.5	116	129	139	149	159	169	179
2.24.55000	2.24.56000	2.24.57000	2.24.58000	2.24.59000	2.24.65000	2.24.66000	2.24.67000	2.24.68000	2.24.69000	2.24.61000	2.24.61100

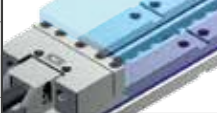
**UPGRADE YOUR VISE APPLICATIONS THROUGH MODULAR ACCESSORIES !**

Art. 313	4.31.35000		4.31.36000
	53		68
Art. 212	1.21.25000		1.21.26000
Art. 246	1.65.56200		1.65.66200
Art. 246G	1.24.6G500		1.24.6G600
Art. 271	2.27.15000		2.27.16000
Art. 391	4.39.15000		4.39.16000
Art. 392	4.39.25000		4.39.26000

Pneumo-hydraulic servo units (complete of hydraulic cylinder + support) for multiple clamping *simultaneous* or *independent*, from 2 to 6 vises. See from page 4.36 to 4.47

**Art. 24**

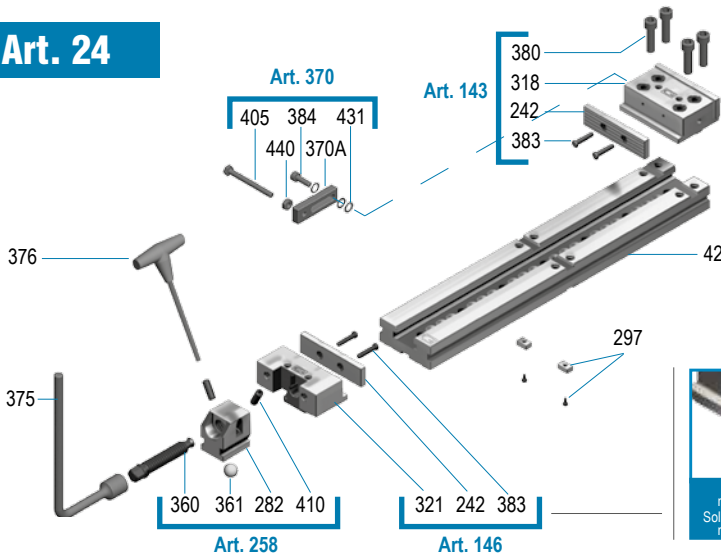

Art.	Pag.
42	2.30
242	4.11
282	4.32
297	4.31
318	4.26
321	4.26
360	4.32
361	4.32
370A	4.31
375	4.31
376	4.31

Art.	Pag.
380	4.24
383	4.24
384	4.24
405	4.31
410	4.32
431	4.24
440	4.24
-	-
-	-
-	-
-	-



**2**

Tipo (grandezza) morsa / Vise (type) size	kN	1 16 kN	2 25 kN	3 30 kN	4 30 kN	5 30 kN	6 30 kN	7 30 kN	8 30 kN
Apertura massima / Maximum spread	A	290	320	360	460	400	500	600	700
	W	75	95	125	145				
	B	30	40	50			60		
	C	35	40	50			58		
	D	460	520	580	680	666	766	866	966
	G	75	95	125	145				
	kg	9.4	15.8	29.8	32.8	44.8	49.8	54.8	59.8
	Cod.	2.25.12900	2.25.23200	2.25.33600	2.25.34600	2.25.44000	2.25.45000	2.25.46000	2.25.47000

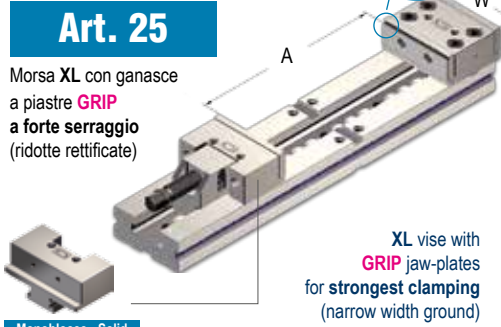

Monoblocco - Solid

**AMPLIA LE TUE APPLICAZIONI TRAMITE GLI ACCESSORI MODULARI !**

Art. 313R Piastre magnetiche parallele piane Magnetic parallel plates	Cod.	4.31.3R100	4.31.3R200	4.31.3R300	4.11.3R400
	H	23	33	43	53

Art. 218 Ganasce mobile prismatica Prismatic movable jaw	Cod.	2.21.81000	2.21.82000	2.21.83000	2.21.84000

Art. 247 Piastra piana in acciaio lavorabile Machinable steel straight jaw plate	Cod.	1.24.71000	1.24.72000	1.24.73000	1.24.74000

Art. 247G <b>NEW!</b> Piastra piana ridotta con inserti GRIP Narrow width straight jaw plate with GRIP inserts	Cod.	1.24.7G100	1.24.7G200	1.24.7G300	1.24.7G400

Art. 271 Supporto di serraggio con cilindro idraulico Clamping support with hydraulic cylinder	Cod.	2.27.11000	2.27.12000	2.27.13000	2.27.14000

Art. 271 Art. 403 Art. 393	Art. 391 CNC / CNC	Cod.	4.39.11000	4.39.12000	4.39.13000	4.39.14000

Art. 392 Pneumatico / Air control	Cod.	4.39.21000	4.39.22000	4.39.23000	4.39.24000

 Servocomandi oleopneumatici (completi di 1 cilindro e supporto) per serraggi multipli **contemporanei** o **indipendenti**, da 2 a 6 morse. Vedi da pag. 4.36 a 4.47

- Dotazione standard:**
- 1 arresto laterale Art. 370
  - 1 coppia di tasselli di posizionamento Art. 297 (Standard per cava da 16 mm; altre dimensioni a richiesta senza variazione di prezzo)
  - 1 chiave a pipa Art. 375 ■ 1 chiave a "T" Art. 376

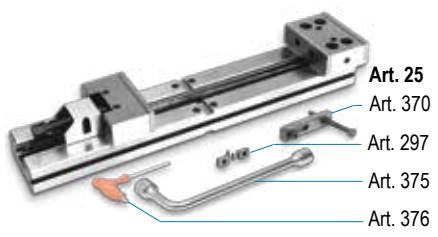



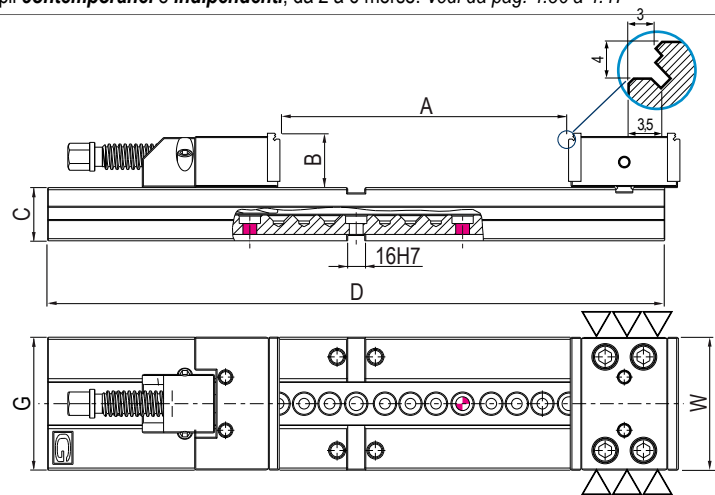

- Standard equipment:**
- 1 workshop Art. 370
  - 1 pair of positioning key-nuts Art. 297 (Standard for 16 mm slot. Other dimensions available on request without price change)
  - 1 box wrench Art. 375 ■ 1 T-wrench Art. 376



 Vedi gruppo 4 per gamma completa accessori  
 See group 4 for complete range of accessories

5 40 kN					6 40 kN						
500	600	700	800	900	500	600	700	800	900	1000	1100
		170						195			
		65						80			
		70						78			
805	905	1005	1105	1205	900	1000	1100	1200	1300	1400	1500
		170						195			
82.5	88.5	96.5	103.5	110.5	116	129	139	149	159	169	179
2.25.55000	2.25.56000	2.25.57000	2.25.58000	2.25.59000	2.25.65000	2.25.66000	2.25.67000	2.25.68000	2.25.69000	2.25.61000	2.25.61100

**UPGRADE YOUR VISE APPLICATIONS THROUGH MODULAR ACCESSORIES !**

<b>Art. 313</b>	4.31.3R500		4.31.3R600
	53		68
<b>Art. 218</b>	2.21.85000		2.21.86000
<b>Art. 247</b>	1.24.75000		1.24.76000
<b>Art. 247G</b>	1.24.7G500		1.24.7G600
<b>Art. 271</b>	2.27.15000		2.27.16000
<b>Art. 391</b>	4.39.15000		4.39.16000
<b>Art. 392</b>	4.39.25000		4.39.26000

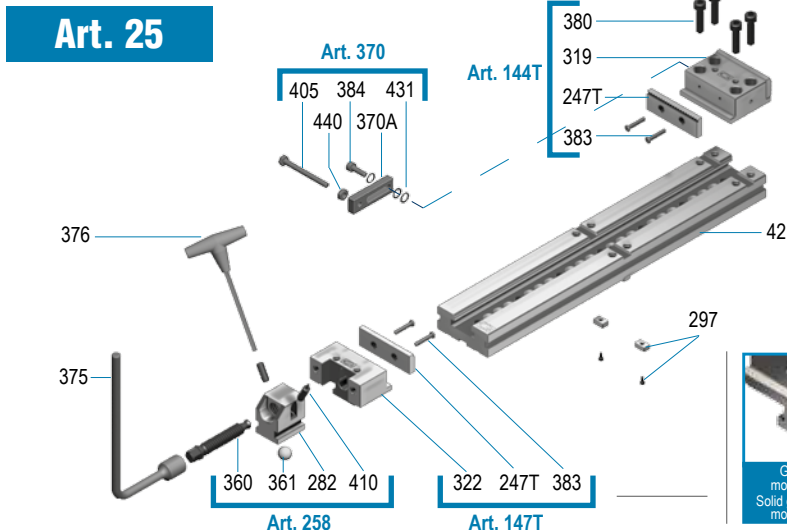
Pneumo-hydraulic servo units (complete of hydraulic cylinder + support) for multiple clamping *simultaneous* or *independent*, from 2 to 6 vises. See from page 4.36 to 4.47



Art.	Pag.	Art.	Pag.
<b>42</b>	2.30	<b>380</b>	4.24
<b>247T</b>	4.11	<b>383</b>	4.24
<b>282</b>	4.32	<b>384</b>	4.24
<b>297</b>	4.31	<b>405</b>	4.31
<b>319</b>	4.26	<b>410</b>	4.32
<b>322</b>	4.26	<b>431</b>	4.24
<b>360</b>	4.32	<b>440</b>	4.24
<b>361</b>	4.32	-	-
<b>370A</b>	4.31	-	-
<b>375</b>	4.31	-	-
<b>376</b>	4.31	-	-

2

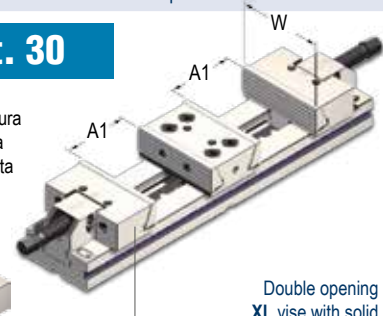
Tipo (grandezza) morsa / Vise (type) size		1		2		3		4	
	kN	16 kN		25 kN		30 kN		30 kN	
Apertura massima / Maximum spread	A1	2 x 90	2 x 100	2 x 110	2 x 160	2 x 120	2 x 170	2 x 220	2 x 270
<b>Art. 30</b> Morsa XL a doppia apertura con ganascia mobile guidata monoblocco 	W	100	125	150		175			
	B	30	40	50		60			
	C	35	40	50		58			
	D	460	520	580	680	666	766	866	966
	G	75	95	125		145			
	kg	14.5	21	39	43	59	64	69	74
	Cod.	3.31.00600	3.32.10600	3.33.20600	3.33.30600	3.34.20600	3.34.30600	3.34.40600	3.34.50600

**AMPLIA LE TUE APPLICAZIONI TRAMITE GLI ACCESSORI MODULARI !**

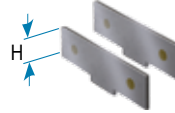
Art. 313	Cod.	4.31.31000	4.31.32000	4.31.33000	4.31.34000
Piastre magnetiche parallele piane Magnetic parallel plates 	H	23	33	43	53

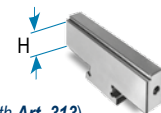
Art. 212	Cod.	1.21.21000	1.21.22000	1.21.23000	1.21.24000
Ganascia mobile intermedia (da usare con Art. 313) Intermediate movable jaw (to be used with Art. 313) 	H				

Art. 217	Cod.	2.21.71000	2.21.72000	2.21.73000	2.21.74000
Ganascia mobile prismatica Prismatic movable jaw 					

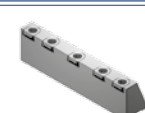
Art. 242G	Cod.	1.24.2G100	1.24.2G200	1.24.2G300	1.24.2G400
Piastra piana con inserti GRIP Straight jaw plate with GRIP inserts 					

Art. 271	Cod.	2.27.11000	2.27.12000	2.27.13000	2.27.14000
Supporto di serraggio con cilindro idraulico Clamping support with hydraulic cylinder 					

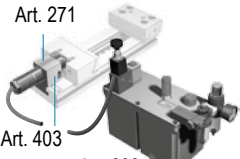
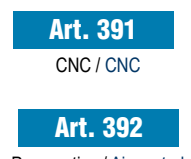
Art. 271	Cod.	4.39.11000	4.39.12000	4.39.13000	4.39.14000
Art. 271 Supporto di serraggio con cilindro idraulico Clamping support with hydraulic cylinder CNC / CNC 					
Art. 391	Cod.	4.39.21000	4.39.22000	4.39.23000	4.39.24000
Art. 391 Supporto di serraggio con cilindro pneumatico Clamping support with pneumatic cylinder Pneumatico / Air control 					

 Servocomandi oleopneumatici (completi di 1 cilindro e supporto) per serraggi multipli **contemporanei** o **indipendenti**, da 2 a 6 morsa. Vedi da pag. 4.36 a 4.47

**Dotazione standard:**

- 2 arresti laterali Art. 370
  - 1 coppia di tasselli di posizionamento Art. 297  
(Standard per cava da 16 mm; altre dimensioni a richiesta senza variazione di prezzo)
  - 1 chiave a pipa Art. 375 ■ 1 chiave a "T" Art. 376
- Extra per ogni foro calibrato (tolleranza F7): € 85,00

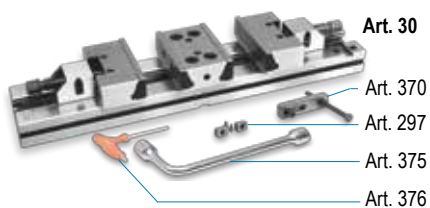
**Standard equipment:**



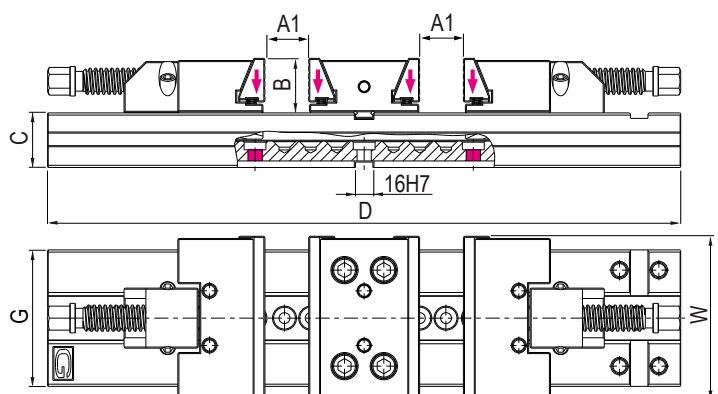

- 2 workstops Art. 370
- 1 pair of positioning key-nuts Art. 297  
(Standard for 16 mm slot. Other dimensions available on request without price change)
- 1 box wrench Art. 375 ■ 1 T-wrench Art. 376

 Vedi gruppo 4 per gamma completa accessori  
 See group 4 for complete range of accessories

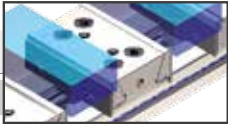

5 40 kN					6 40 kN						
2 x 150	2 x 200	2 x 250	2 x 300	2 x 350	2 x 160	2 x 210	2 x 260	2 x 310	2 x 360	2 x 410	2 x 460
		200						300			
		65						80			
		70						78			
805	905	1005	1105	1205	900	1000	1100	1200	1300	1400	1500
		170						195			
96	102	108	114	120	155	163	171	179	187	195	213
3.35.20600	3.35.30600	3.35.40600	3.35.50600	3.35.60600	3.36.20600	3.36.30600	3.36.40600	3.36.50600	3.36.60600	3.36.70600	3.36.80600

**UPGRADE YOUR VISE APPLICATIONS THROUGH MODULAR ACCESSORIES !**

<b>Art. 313</b>	4.31.35000		4.31.36000
	53		68
<b>Art. 212</b>	1.21.25000		1.21.26000
<b>Art. 217</b>	2.21.75000		2.21.76000
<b>Art. 242G</b>	1.24.2G500		1.24.2G600
<b>Art. 271</b>	2.27.15000		2.27.16000
<b>Art. 391</b>	4.39.15000		4.39.16000
<b>Art. 392</b>	4.39.25000		4.39.26000

Pneumo-hydraulic servo units (complete of hydraulic cylinder + support) for multiple clamping *simultaneous* or *independent*, from 2 to 6 vises. See from page 4.36 to 4.47

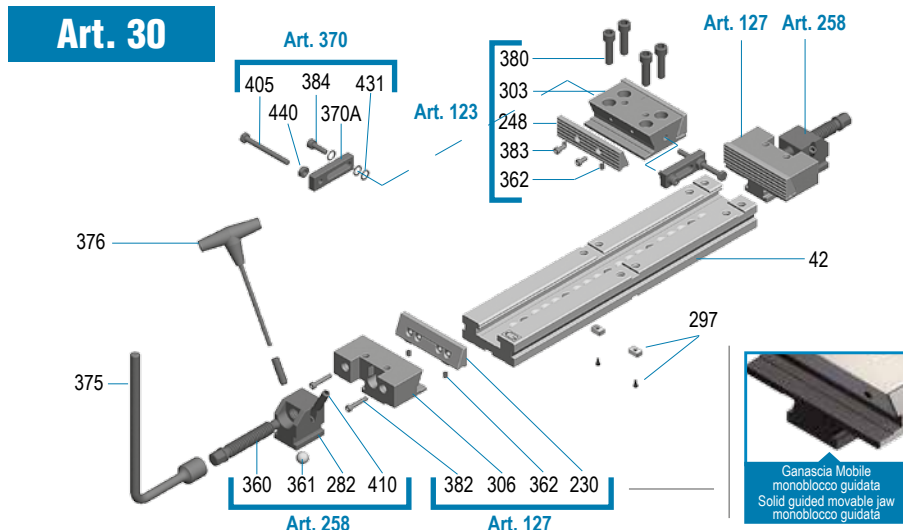

Art.	Pag.	Art.	Pag.
42	2.30	375	4.31
230	4.9	376	4.31
248	4.9	380	4.24
282	4.32	382	4.24
297	4.31	383	4.24
303	4.25	384	4.24
306	4.25	405	4.31
360	4.32	410	4.32
361	4.32	431	4.24
362	4.24	440	4.24
370A	4.31	-	-

2

Tipo (grandezza) morsa / Vise (type) size	kN	1		2		3		4	
		16 kN	25 kN	30 kN	30 kN	30 kN	30 kN	30 kN	
Apertura massima / Maximum spread	A1	2 x 90	2 x 100	2 x 110	2 x 160	2 x 120	2 x 170	2 x 220	2 x 270
<b>Art. 32</b> Morsa XL a doppia apertura con ganasce ridotte rettificate. (Maggior Pressione) Double opening XL vise with narrow ground jaws (Higher Pressure)	W	75	95	125				145	
	B	30	40	50				60	
	C	35	40	50				58	
	D	460	520	580	680	666	766	866	966
	G	75	95	125				145	
	kg	13.5	19.5	36	40	56	61	66	71
	Cod.	3.31.00720	3.32.10720	3.33.20720	3.33.30720	3.34.20720	3.34.30720	3.34.40720	3.34.50720

Monoblocco - Solid

**AMPLIA LE TUE APPLICAZIONI TRAMITE GLI ACCESSORI MODULARI !**

Art. 313R	Cod.	4.31.3R100	4.31.3R200	4.31.3R300	4.31.3R400
Piastre magnetiche parallele piane Magnetic parallel plates	H	23	33	43	53

Art. 213	Cod.	1.21.31000	1.21.32000	1.21.33000	1.21.34000
Ganascia mobile intermedia (da usare con Art. 313R) Intermediate movable jaw (to be used with Art. 313R)	H				

Art. 218	Cod.	2.21.81000	2.21.82000	2.21.83000	2.21.84000
Ganascia mobile prismatica Prismatic movable jaw					

Art. 243G	Cod.	1.24.3G100	1.24.3G200	1.24.3G300	1.24.3G400
Piastra ganascia ridotta con inserti GRIP Narrow width jaw plate with GRIP inserts					

Art. 271	Cod.	2.27.11000	2.27.12000	2.27.13000	2.27.14000
Supporto di serraggio con cilindro idraulico Clamping support with hydraulic cylinder					

Art. 391	Cod.	4.39.11000	4.39.12000	4.39.13000	4.39.14000
CNC / CNC					
Art. 392	Cod.	4.39.21000	4.39.22000	4.39.23000	4.39.24000
Pneumatico / Air control					

 Servocomandi oleopneumatici (completi di 1 cilindro e supporto) per serraggi multipli **contemporanei** o **indipendenti**, da 2 a 6 morse. Vedi da pag. 4.36 a 4.47

- Dotazione standard:**
- 2 arresti laterali Art. 370
  - 1 coppia di tasselli di posizionamento Art. 297 (Standard per cava da 16 mm; altre dimensioni a richiesta senza variazione di prezzo)
  - 1 chiave a pipa Art. 375 ■ 1 chiave a "T" Art. 376

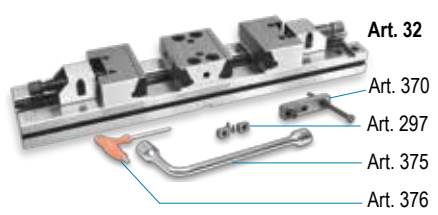

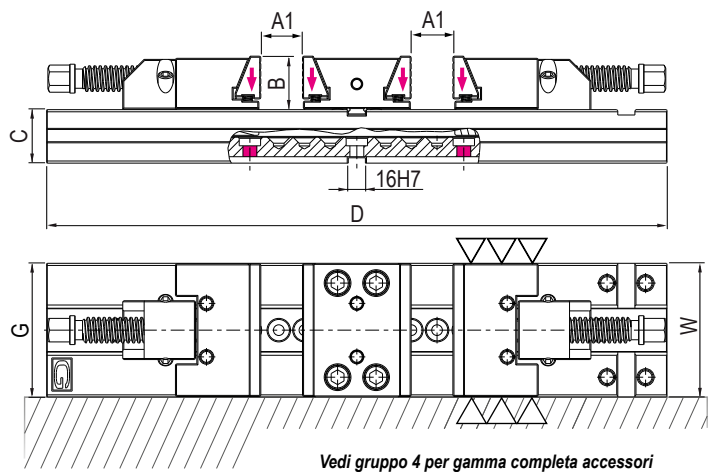

- Standard equipment:**
- 2 workstops Art. 370
  - 1 pair of positioning key-nuts Art. 297 (Standard for 16 mm slot. Other dimensions available on request without price change)
  - 1 box wrench Art. 375 ■ 1 T-wrench Art. 376

 Vedi gruppo 4 per gamma completa accessori  
 See group 4 for complete range of accessories

5 40 kN					6 40 kN						
2 x 150	2 x 200	2 x 250	2 x 300	2 x 350	2 x 160	2 x 210	2 x 260	2 x 310	2 x 360	2 x 410	2 x 460
		170						195			
		65						80			
		70						78			
805	905	1005	1105	1205	900	1000	1100	1200	1300	1400	1500
		170						195			
93	99	105	108	117	144	152	160	168	176	184	202
3.35.20720	3.35.30720	3.35.40720	3.35.50720	3.35.60720	3.36.20720	3.36.30720	3.36.40720	3.36.50720	3.36.60720	3.36.70720	3.36.80720

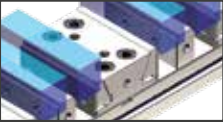
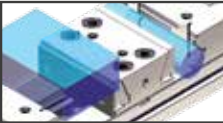
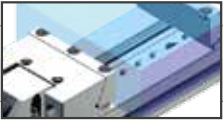
**UPGRADE YOUR VISE APPLICATIONS THROUGH MODULAR ACCESSORIES !**

<b>Art. 313R</b>	4.31.3R500		4.31.3R600
	53		68
<b>Art. 213</b>	1.21.35000		1.21.36000
<b>Art. 218</b>	2.21.85000		2.21.86000
<b>Art. 243G</b>	1.24.3G500		1.24.3G600
<b>Art. 271</b>	2.27.15000		2.27.16000
<b>Art. 391</b>	4.39.15000		4.39.16000
<b>Art. 392</b>	4.39.25000		4.39.26000

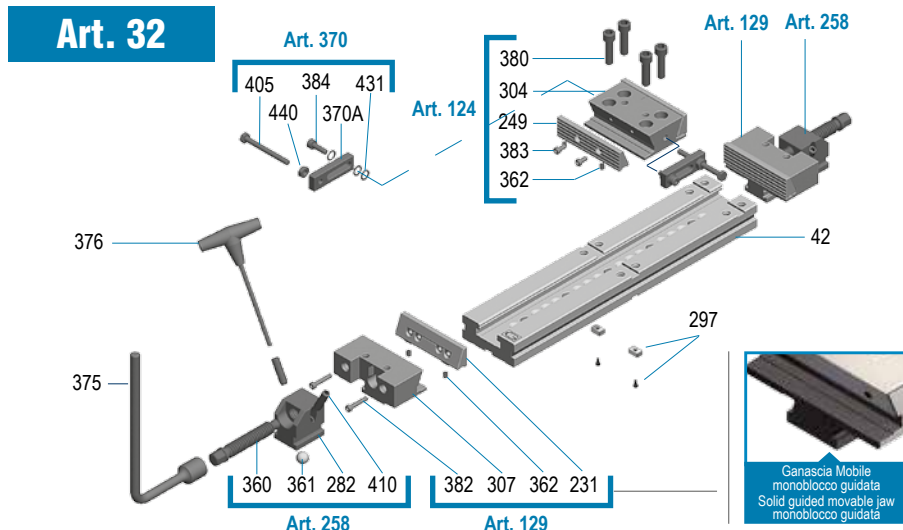
 Pneumo-hydraulic servo units (complete of hydraulic cylinder + support) for multiple clamping **simultaneous** or **independent**, from 2 to 6 vises. See from page 4.36 to 4.47

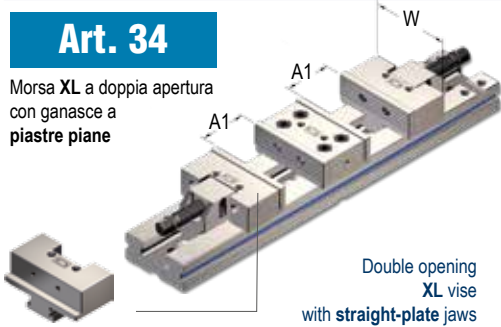

Art.	Pag.	Art.	Pag.
<b>42</b>	2.30	<b>375</b>	4.31
<b>231</b>	4.9	<b>376</b>	4.31
<b>249</b>	4.9	<b>380</b>	4.24
<b>282</b>	4.32	<b>382</b>	4.24
<b>297</b>	4.31	<b>383</b>	4.24
<b>304</b>	4.25	<b>384</b>	4.24
<b>307</b>	4.25	<b>405</b>	4.31
<b>360</b>	4.32	<b>410</b>	4.32
<b>361</b>	4.32	<b>431</b>	4.24
<b>362</b>	4.24	<b>440</b>	4.24
<b>370A</b>	4.31	-	-

2

Tipo (grandezza) morsa / Vise (type) size		1		2		3		4	
	kN	16 kN	25 kN	30 kN		30 kN			
Apertura massima / Maximum spread	A1	2 x 90	2 x 100	2 x 110	2 x 160	2 x 120	2 x 170	2 x 220	2 x 270
<b>Art. 34</b> Morsa XL a doppia apertura con ganasce a piastre piane  Double opening XL vise with straight-plate jaws Monoblocco - Solid	W	100	125	150		175			
	B	30	40	50		60			
	C	35	40	50		58			
	D	460	520	580	680	666	766	866	966
	G	75	95	125		145			
	kg	9.4	15.8	29.8	32.8	44.8	49.8	54.8	59.8
	Cod.	2.34.19000	2.34.21000	2.34.31100	2.34.31600	2.34.41200	2.34.41700	2.34.42200	2.34.42700

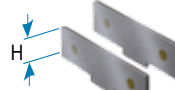
**AMPLIA LE TUE APPLICAZIONI TRAMITE GLI ACCESSORI MODULARI !**

Art. 313	Cod.		4.31.31000	4.31.32000	4.31.33000	4.31.34000
Piastre magnetiche parallele piane Magnetic parallel plates		H	23	33	43	53

Art. 212	Cod.		1.21.21000	1.21.22000	1.21.23000	1.21.24000
Ganascia mobile intermedia (da usare con Art. 313) Intermediate movable jaw (to be used with Art. 313)		H				

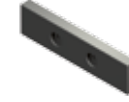
Art. 246	Cod.		1.65.16200	1.65.26200	1.65.36200	1.65.46200
Piastra piana in acciaio lavorabile Machinable steel straight jaw plate						

Art. 246G	Cod.		1.24.6G100	1.24.6G200	1.24.6G300	1.24.6G400
Piastra piana con inserti GRIP Straight jaw plate with GRIP inserts						

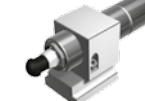
Art. 271	Cod.		2.27.11000	2.27.12000	2.27.13000	2.27.14000
Supporto di serraggio con cilindro idraulico Clamping support with hydraulic cylinder						

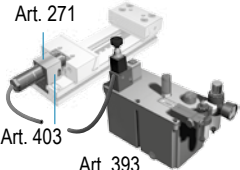
Art. 391	Cod.		4.39.11000	4.39.12000	4.39.13000	4.39.14000
CNC / CNC						

Art. 392	Cod.		4.39.21000	4.39.22000	4.39.23000	4.39.24000
Pneumatico / Air control						

 Servocomandi oleopneumatici (completi di 1 cilindro e supporto) per serraggi multipli **contemporanei** o **indipendenti**, da 2 a 6 morse. Vedi da pag. 4.36 a 4.47

**Dotazione standard:**

- 2 arresti laterali Art. 370
- 1 coppia di tasselli di posizionamento Art. 297  
(Standard per cava da 16 mm; altre dimensioni a richiesta senza variazione di prezzo)
- 1 chiave a pipa Art. 375 ■ 1 chiave a "T" Art. 376

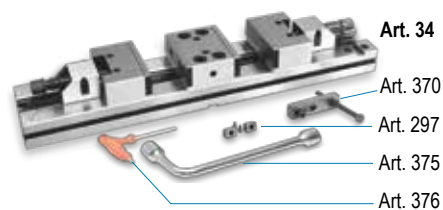

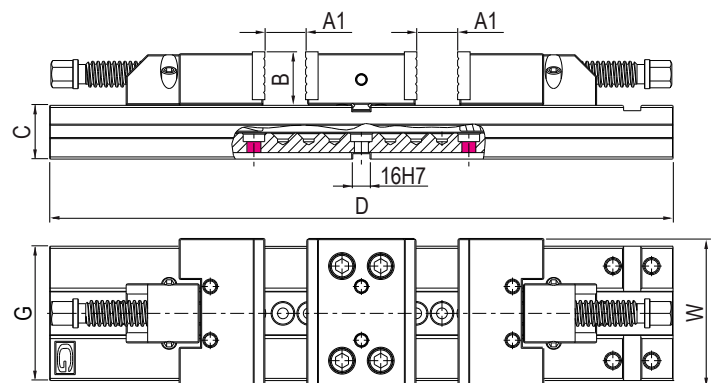

**Standard equipment:**

- 2 workstops Art. 370
- 1 pair of positioning key-nuts Art. 297  
(Standard for 16 mm slot. Other dimensions available on request without price change)
- 1 box wrench Art. 375 ■ 1 T-wrench Art. 376



 Vedi gruppo 4 per gamma completa accessori  
 See group 4 for complete range of accessories

5 40 kN					6 40 kN						
2 x 150	2 x 200	2 x 250	2 x 300	2 x 350	2 x 160	2 x 210	2 x 260	2 x 310	2 x 360	2 x 410	2 x 460
		200						300			
		65						80			
		70						78			
805	905	1005	1105	1205	900	1000	1100	1200	1300	1400	1500
		170						195			
82.5	88.5	96.5	103.5	110.5	116	129	139	149	159	169	179
2.34.51500	2.34.52000	2.34.52500	2.34.53000	2.34.53500	2.34.61600	2.34.62100	2.34.62600	2.34.63100	2.34.63600	2.34.64100	2.34.64600

**UPGRADE YOUR VISE APPLICATIONS THROUGH MODULAR ACCESSORIES !**

Art. 313	4.31.35000		4.31.36000
	53		68
Art. 212	1.21.25000		1.21.26000
Art. 246	1.65.56200		1.65.66200
Art. 246G	1.24.6G500		1.24.6G600
Art. 271	2.27.15000		2.27.16000
Art. 391	4.39.15000		4.39.16000
Art. 392	4.39.25000		4.39.26000

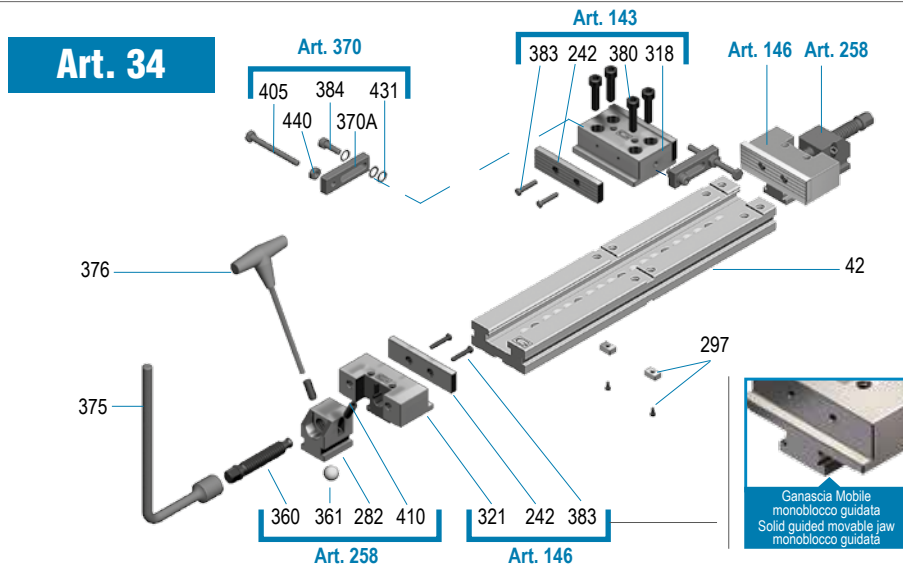
Pneumo-hydraulic servo units (complete of hydraulic cylinder + support) for multiple clamping *simultaneous* or *independent*, from 2 to 6 vises. See from page 4.36 to 4.47



Art.	Pag.	Art.	Pag.
42	2.30	380	4.24
242	4.11	383	4.24
282	4.32	384	4.24
297	4.31	405	4.31
318	4.26	410	4.32
321	4.26	431	4.24
360	4.32	440	4.24
361	4.32	-	-
370A	4.31	-	-
375	4.31	-	-
376	4.31	-	-

2

Tipo (grandezza) morsa / Vise (type) size	(kN)	1		2		3		4	
		16 kN		25 kN		30 kN		30 kN	
Apertura massima / Maximum spread	A1	2 x 90	2 x 100	2 x 110	2 x 160	2 x 120	2 x 170	2 x 220	2 x 270
<b>Art. 35</b>	W	75	95	125			145		
Morsa XL a doppia apertura con piastre ganasce GRIP a forte serraggio (ridotte rettificare)	B	30	40	50			60		
	C	35	40	50			58		
	D	460	520	580	680	666	766	866	966
	G	75	95	125			145		
	kg	9.4	15.8	29.8	32.8	44.8	49.8	54.8	59.8
	Cod.	2.35.19000	2.35.21000	2.35.31100	2.35.31600	2.35.41200	2.35.41700	2.35.42200	2.35.42700

Monoblocco - Solid

**AMPLIA LE TUE APPLICAZIONI TRAMITE GLI ACCESSORI MODULARI !**

<b>Art. 313R</b>	Cod.	4.31.3R100	4.31.3R200	4.31.3R300	4.11.3R400
Piastre magnetiche parallele piane Magnetic parallel plates	H	23	33	43	53

<b>Art. 218</b>	Cod.	2.21.81000	2.21.82000	2.21.83000	2.21.84000
Ganascia mobile prismatica Prismatic movable jaw					

<b>Art. 247</b>	Cod.	1.24.71000	1.24.72000	1.24.73000	1.24.74000
Piastra piana in acciaio lavorabile Machinable steel straight jaw plate					

<b>Art. 247G</b>	Cod.	1.24.7G100	1.24.7G200	1.24.7G300	1.24.7G400
Piastra piana ridotta con inserti GRIP Narrow width straight jaw plate with GRIP inserts					

<b>Art. 271</b>	Cod.	2.27.11000	2.27.12000	2.27.13000	2.27.14000
Supporto di serraggio con cilindro idraulico Clamping support with hydraulic cylinder					

<b>Art. 391</b>	Cod.	4.39.11000	4.39.12000	4.39.13000	4.39.14000
CNC / CNC					

<b>Art. 392</b>	Cod.	4.39.21000	4.39.22000	4.39.23000	4.39.24000
Pneumatico / Air control					

 Servocomandi oleopneumatici (completi di 1 cilindro e supporto) per serraggi multipli **contemporanei** o **indipendenti**, da 2 a 6 morsa. Vedi da pag. 4.36 a 4.47

- Dotazione standard:**
- 2 arresti laterali Art. 370
  - 1 coppia di tasselli di posizionamento Art. 297 (Standard per cava da 16 mm; altre dimensioni a richiesta senza variazione di prezzo)
  - 1 chiave a pipa Art. 375 ■ 1 chiave a "T" Art. 376

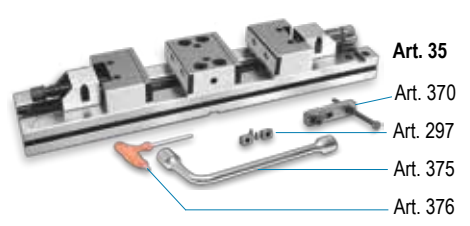



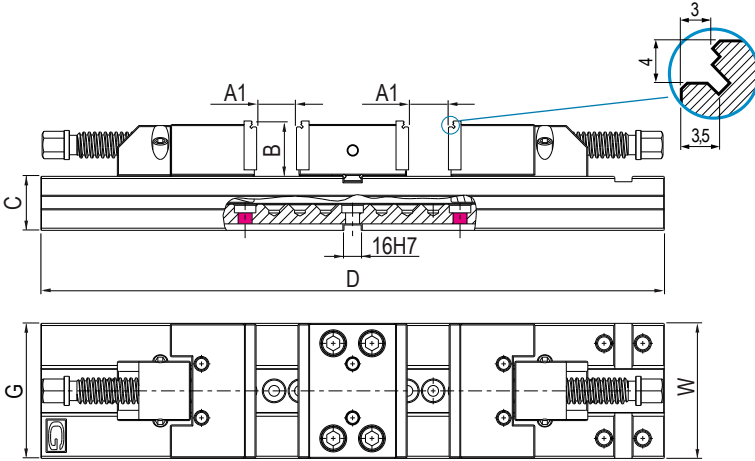

- Standard equipment:**
- 2 workstops Art. 370
  - 1 pair of positioning key-nuts Art. 297 (Standard for 16 mm slot. Other dimensions available on request without price change)
  - 1 box wrench Art. 375 ■ 1 T-wrench Art. 376

 Vedi gruppo 4 per gamma completa accessori  
 See group 4 for complete range of accessories

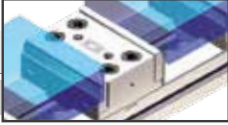
5 40 kN					6 40 kN						
2 x 150	2 x 200	2 x 250	2 x 300	2 x 350	2 x 160	2 x 210	2 x 260	2 x 310	2 x 360	2 x 410	2 x 460
		170						195			
		65						80			
		70						78			
805	905	1005	1105	1205	900	1000	1100	1200	1300	1400	1500
		170						195			
82.5	88.5	96.5	103.5	110.5	116	129	139	149	159	169	179
2.35.51500	2.35.52000	2.35.52500	2.35.53000	2.35.53500	2.35.61600	2.35.62100	2.35.62600	2.35.63100	2.35.63600	2.35.64100	2.35.64600

**UPGRADE YOUR VISE APPLICATIONS THROUGH MODULAR ACCESSORIES !**

<b>Art. 313</b>	4.31.3R500		4.31.3R600
	53		68
<b>Art. 218</b>	2.21.85000		2.21.86000
<b>Art. 247</b>	1.24.75000		1.24.76000
<b>Art. 247G</b>	1.24.7G500		1.24.7G600
<b>Art. 271</b>	2.27.15000		2.27.16000
<b>Art. 391</b>	4.39.15000		4.39.16000
<b>Art. 392</b>	4.39.25000		4.39.26000

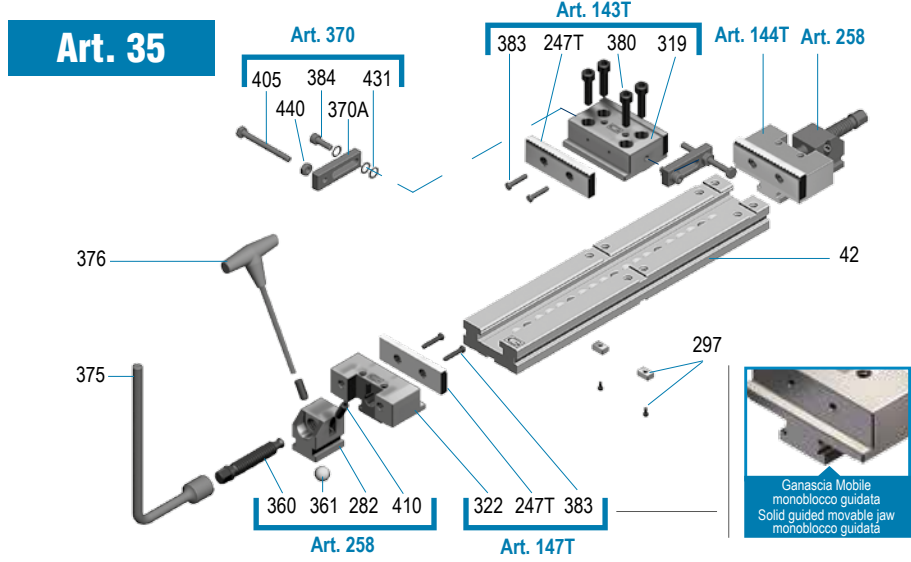
 Pneumo-hydraulic servo units (complete of hydraulic cylinder + support) for multiple clamping *simultaneous* or *independent*, from 2 to 6 vises. See from page 4.36 to 4.47

Art.	Pag.	Art.	Pag.
<b>42</b>	2.30	<b>380</b>	4.24
<b>247T</b>	4.11	<b>383</b>	4.24
<b>282</b>	4.32	<b>384</b>	4.24
<b>297</b>	4.31	<b>405</b>	4.31
<b>319</b>	4.26	<b>410</b>	4.32
<b>322</b>	4.26	<b>431</b>	4.24
<b>360</b>	4.32	<b>440</b>	4.24
<b>361</b>	4.32	-	-
<b>370A</b>	4.31	-	-
<b>375</b>	4.31	-	-
<b>376</b>	4.31	-	-

# MORSE XL CON PIASTRE GANASCE A CAMBIO RAPIDO XL VISES WITH QUICK MANUAL CHANGE JAW PLATES

La Morsa più Evoluta! Dotata del geniale sistema a pettine per la rapida sostituzione delle piastre ganasce discendenti  
The Most Recent Vise! Innovative comb system for quick pull-down jaw plate change

## 1 ALTISSIMA RIPETIBILITÀ DI POSIZIONAMENTO

con particolari perfettamente in squadra

## 1 HIGHEST REPOSITIONING ACCURACY

with perfect square workpieces.

## 2 RICONFIGURAZIONE RAPIDISSIMA

grazie alla piastra ganascia intercambiabile manualmente

## 2 GREAT SAVINGS IN VISE RESETTING TIMES

thanks to the manual interchangeable quick jaw plate

## 3 EFFETTO DISCENDENTE

Effetto discendente amplificato e migliorato e migliore protezione dai trucioli grazie al sistema a pettine

## 3 PULL DOWN ACTION

Increased and better pull down action and better protection from chips thanks to the comb system

Morsa con piastre ganasce a cambio rapido manuale  
(Sistema a pettine)

Vise with quick manual change jaw plates  
(Comb system)

Art. 30A

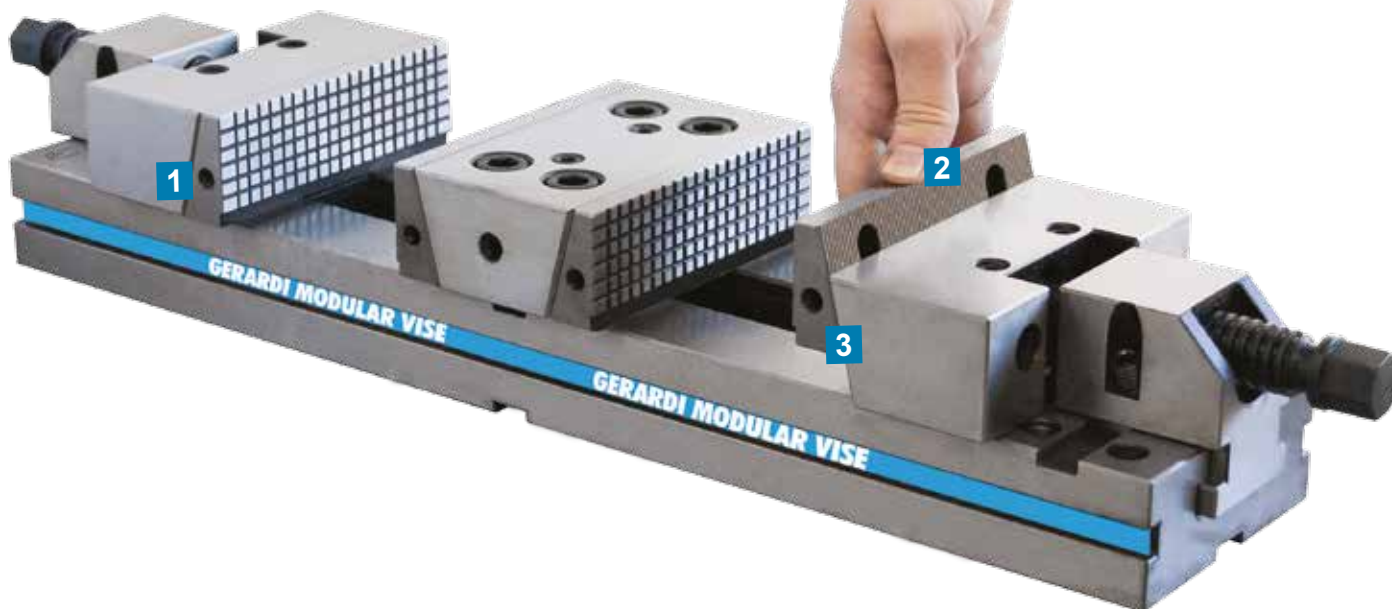

### CARATTERISTICHE E VANTAGGI

- USURA INESISTENTE
- RAPIDITA' DEI SERRAGGI
- MODULARITA' & VERSATILITA'
- PRECISIONI  $\pm 0,02$  mm
- RIGIDITA' & SICUREZZA
- DESIGN COMPATTO E MANEGGEVOLEZZA

Si rimanda a quanto esposto a pag. 1.4 e 1.5 (morse serie STANDARD)

### TECHNICAL FEATURES and ADVANTAGES

- NO WEAR
- QUICK CLAMPING
- MODULARITY & VERSATILITY
- HIGHEST ACCURACIES  $\pm 0,02$  mm
- RIGIDITY & SAFETY
- SPACE SAVING DESIGN & HANDY

See pag. 1.4 and 1.5 (STANDARD series vises)



# PIASTRE GANASCE DISCENDENTI INTERCAMBIABILI MANUALMENTE PULL DOWN JAW PLATES INTERCHANGEABLE by HAND

2

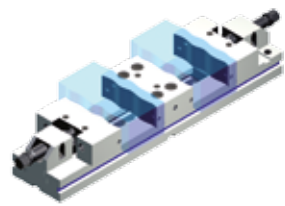

**Art. 230B**  
Dolce  
Soft

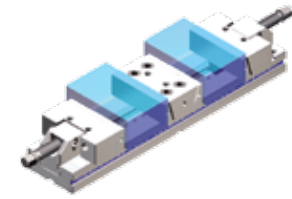

**Art. 230C**  
Liscia  
Smooth

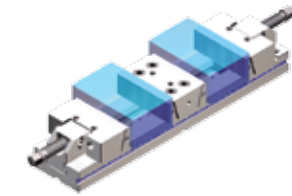

**Art. 230D**  
Zigrinata  
Serrated

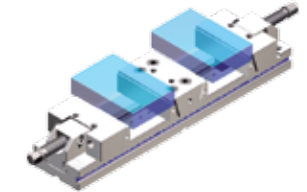

**Art. 230E**  
Con gradino  
With step

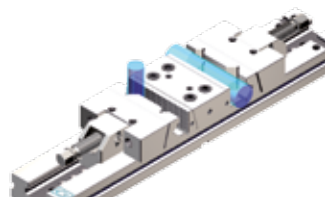
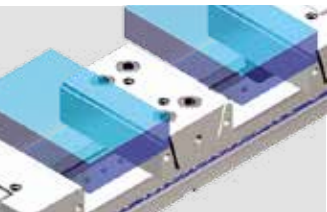
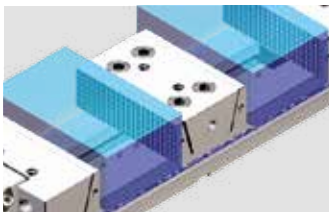
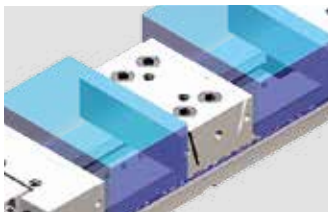
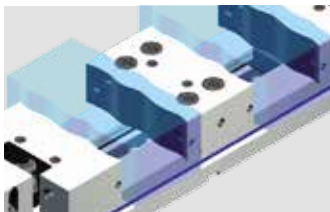

**Art. 230F**  
Prismatica  
Prismatic

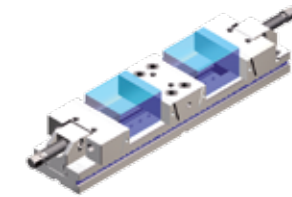

**Art. 230G**  
Con arresto a 90°  
With 90° stop

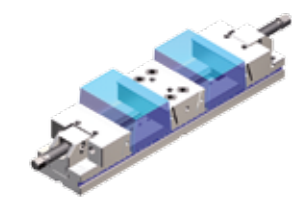

**Art. 230H**  
Bombata  
Round

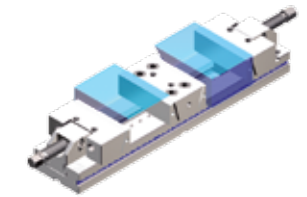

**Art. 230M**  
Angolo di 30° o 45°  
30° or 45° angle

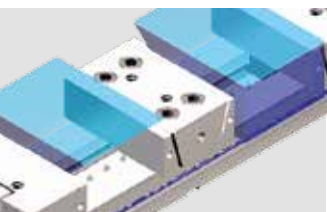
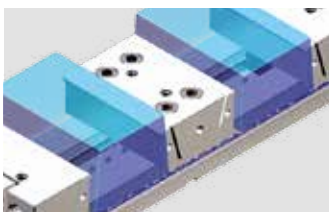
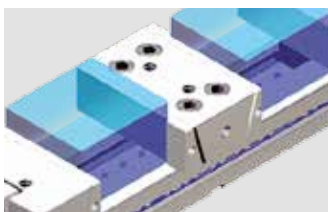
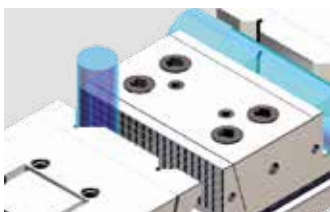

## PORTAPIASTRE / THE RACK

Completo di piastre ganasce a cambio rapido a gradino Art.230E  
Complete of quick change step jaw plates Art.230E

Vedi Pag. 4.18 - See Page.4.18

2

Tipo (grandezza) morsa / Vise (type) size	kN	1 16 kN	2 25 kN	3 30 kN		4 30 kN			
Apertura massima / Maximum spread	A	290	320	360	460	400	500	600	700
	W	96	121	146		171			
	B	28	38	48		58			
	C	35	40	50		58			
	D	460	520	580	680	666	766	866	966
	G	75	95	125		145			
	kg	6.8	12.9	25.5	29	37	42	47	52
	Cod.	2.20.A1290	2.20.A2320	2.20.A3360	2.20.A3460	2.20.A4400	2.20.A4500	2.20.A4600	2.20.A4700

**Art. 20A**

Morsa \*XL a apertura singola con piastre ganasce a cambio rapido manuale (Sistema a pettine)  
 \* Serraggi disassati lateralmente non possibili

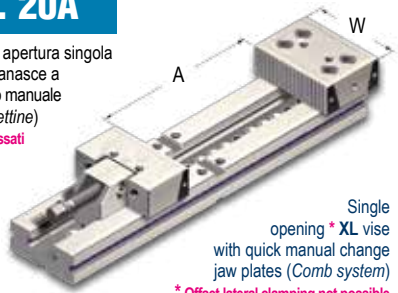

Single opening \*XL vise with quick manual change jaw plates (Comb system)  
 \* Offset lateral clamping not possible

**AMPLIA LE TUE APPLICAZIONI TRAMITE GLI ACCESSORI MODULARI !**
**Art. 230E**

Piastra ganascia intercambiabile  
 Interchangeable jaw plate

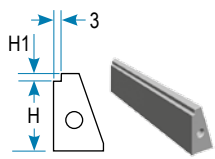

	Cod.	4.23.0E101	4.23.0E201	4.23.0E301	4.23.0E401
H	23	33	43	53	
H1	5	5	5	5	

**Art. 212**

Ganascia mobile intermedia (da usare con Art. 230E)  
 Intermediate movable jaw (to be used with Art. 230E)



	Cod.	1.21.21000	1.21.22000	1.21.23000	1.21.24000

**Art. 230B**

Piastra ganascia intercambiabile dolce  
 Soft interchangeable jaw plate

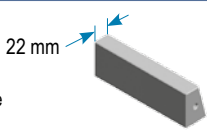

	Cod.	4.23.0B101	4.23.0B201	4.23.0B301	4.23.0B401

**Art. 230F**

Piastra ganascia intercambiabile prismatica  
 Prismatic interchangeable jaw plate

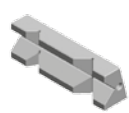

	Cod.	4.23.0F101	4.23.0F201	4.23.0F301	4.23.0F401

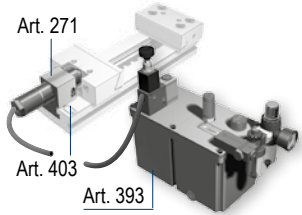
**Art. 391**  
 CNC / CNC

**Art. 392**  
 Pneumatico / Air control

	Cod.	4.39.11000	4.39.12000	4.39.13000	4.39.14000
	Cod.	4.39.21000	4.39.22000	4.39.23000	4.39.24000

Servocomandi oleopneumatici (completi di 1 cilindro e supporto) per serraggi multipli **contemporanei** o **indipendenti**, da 2 a 6 morse. Vedi da pag. 4.36 a 4.47

**Dotazione standard:**

- 1 arresto laterale Art. 370
- 1 coppia di tasselli di posizionamento Art. 297 (Standard per cava da 16 mm; altre dimensioni a richiesta senza variazione di prezzo)
- 2 tappi Art. 291 ■ 1 chiave a pipa Art. 375 ■ 1 chiave a "T" Art. 376

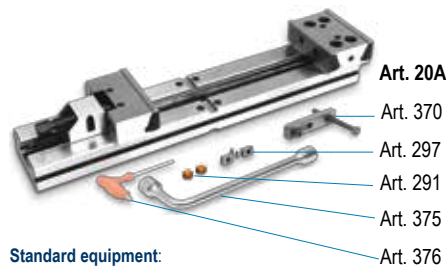
**Standard equipment:**

- 1 workstop Art. 370
- 1 pair of positioning key-nuts Art. 297 (Standard for 16 mm slot. Other dimensions available on request without price change)
- 2 inserts Art. 291 ■ 1 box wrench Art. 375 ■ 1 T-wrench Art. 376

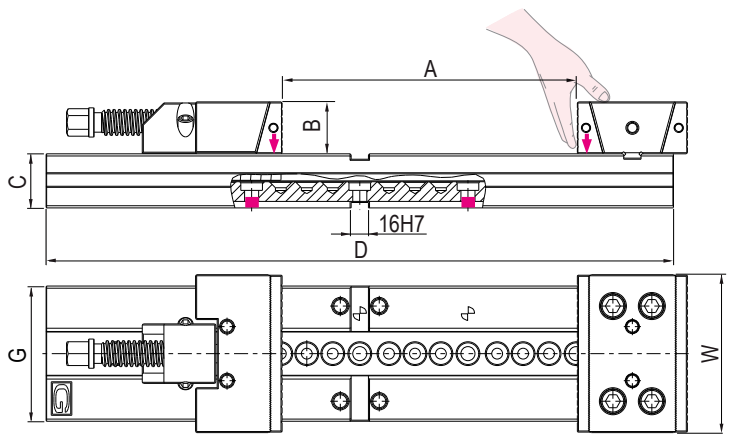

Vedi gruppo 4 per gamma completa accessori  
 See group 4 for complete range of accessories



5 40 kN					6 40 kN						
500	600	700	800	900	500	600	700	800	900	1000	1100
		196						296			
		63						78			
		70						78			
805	905	1005	1105	1205	900	1000	1100	1200	1300	1400	1500
		170						195			
64	69	74	79	84	95	105	115	125	135	145	155
2.20.A5500	2.20.A5600	2.20.A5700	2.20.A5800	2.20.A5900	2.20.A6500	2.20.A6600	2.20.A6700	2.20.A6800	2.20.A6900	2.20.A6100	2.20.A6110

**UPGRADE YOUR VISE APPLICATIONS THROUGH MODULAR ACCESSORIES !**

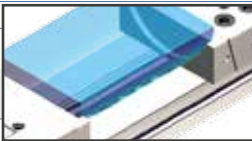
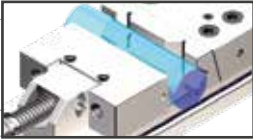
4.23.0E501		4.23.0E601
<b>Art. 230E</b>		
H	53	68
H1	10	10
4.23.0B501		4.23.0B601
<b>Art. 230B</b>		
4.23.0F501		4.23.0F601
<b>Art. 230F</b>		
4.39.15000		4.39.16000
<b>Art. 391</b>		
4.39.25000		4.39.26000
<b>Art. 392</b>		

Pneumo-hydraulic servo units (complete of hydraulic cylinder + support) for multiple clamping *simultaneous* or *independent*, from 2 to 6 vises. See from page 4.36 to 4.47

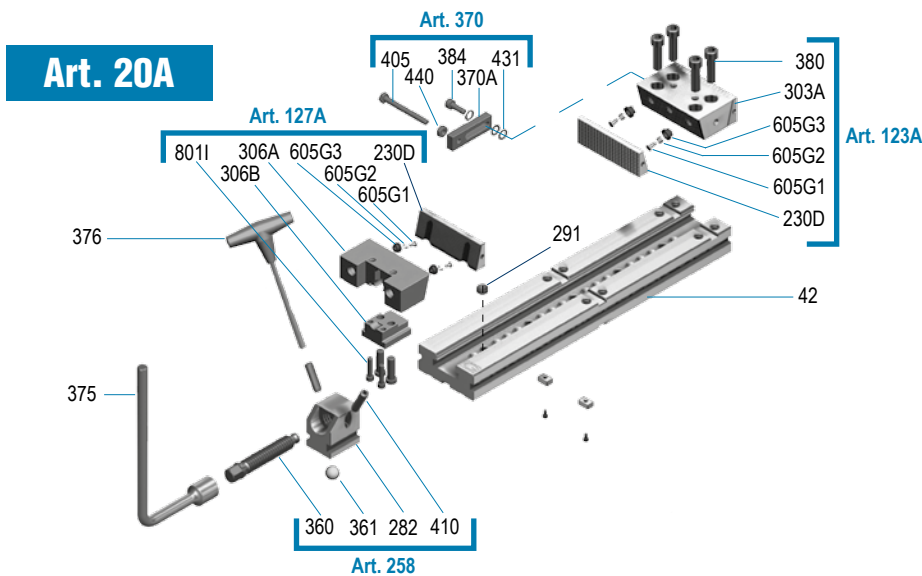

Art.	Pag.
42	2.30
230D	4.17
282	4.32
291	4.31
297	4.31
303A	4.26
306A	4.26
306B	4.26
360	4.32
361	4.32
370A	4.31
375	4.31

Art.	Pag.
376	4.31
380	4.24
384	4.24
405	4.31
410	4.32
431	4.24
440	4.24
605G1	4.18
605G2	4.18
605G3	4.18
801I	5.61
-	-

2

Tipo (grandezza) morsa / Vise (type) size	kN	1		2		3		4	
		16 kN	25 kN	30 kN	30 kN	30 kN	30 kN	30 kN	
Apertura massima / Maximum spread	A1	2 x 90	2 x 100	2 x 110	2 x 160	2 x 120	2 x 170	2 x 220	2 x 270
	W	96	121	146				171	
	B	28	38	48				58	
	C	35	40	50				58	
	D	460	520	580	680	666	766	866	966
	G	75	95	125				145	
	kg	6.8	12.9	25.5	29	37	42	47	52
	Cod.	2.30.A190	2.30.A2100	2.30.A3110	2.30.A3160	2.30.A4120	2.30.A4170	2.30.A4220	2.30.A4270

**Art. 30A**

Morsa \*XL a doppia apertura con ganasce a cambio rapido (sistema a pettine)

\* Serraggi disassati lateralmente non possibili

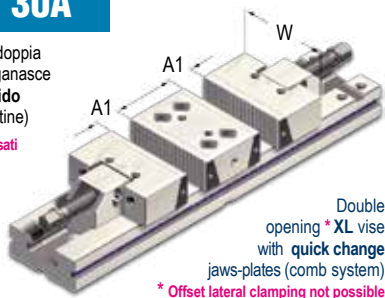

Double opening \*XL vise with quick change jaws-plates (comb system)

\* Offset lateral clamping not possible

**AMPLIA LE TUE APPLICAZIONI TRAMITE GLI ACCESSORI MODULARI !**
**Art. 230E**

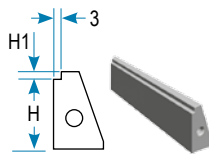
 Piastra ganascia intercambiabile  
 Interchangeable jaw plate

	Cod.	4.23.0E101	4.23.0E201	4.23.0E301	4.23.0E401
H	23	33	43	53	
H1	5	5	5	5	

**Art. 212**

 Ganascia mobile intermedia  
 (da usare con Art. 230E)

Intermediate movable jaw (to be used with Art. 230E)

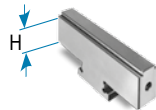

	Cod.	1.21.21000	1.21.22000	1.21.23000	1.21.24000

**Art. 230B**

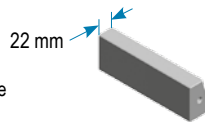
 Piastra ganascia intercambiabile dolce  
 Soft interchangeable jaw plate

	Cod.	4.23.0B101	4.23.0B201	4.23.0B301	4.23.0B401

**Art. 230F**

 Piastra ganascia intercambiabile prismatica  
 Prismatic interchangeable jaw plate

	Cod.	4.23.0F101	4.23.0F201	4.23.0F301	4.23.0F401

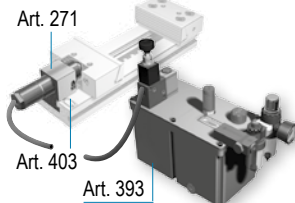
**Art. 391**  
 CNC / CNC

**Art. 392**  
 Pneumatico / Air control

	Cod.	4.39.11000	4.39.12000	4.39.13000	4.39.14000
	Cod.	4.39.21000	4.39.22000	4.39.23000	4.39.24000

 Servocomandi oleopneumatici (completi di 1 cilindro e supporto) per serraggi multipli **contemporanei** o **indipendenti**, da 2 a 6 morse. Vedi da pag. 4.36 a 4.47

**Dotazione standard:**

- 2 arresti laterali Art. 370
- 1 coppia di tasselli di posizionamento Art. 297 (Standard per cava da 16 mm; altre dimensioni a richiesta senza variazione di prezzo)
- 2 tappi Art. 291 ■ 1 chiave a pipa Art. 375 ■ 1 chiave a "T" Art. 376

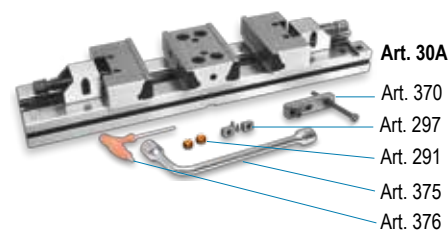
**Standard equipment:**

- 2 workstops Art. 370
- 1 pair of positioning key-nuts Art. 297 (Standard for 16 mm slot. Other dimensions available on request without price change)
- 2 inserts Art. 291 ■ 1 box wrench Art. 375 ■ 1 T-wrench Art. 376

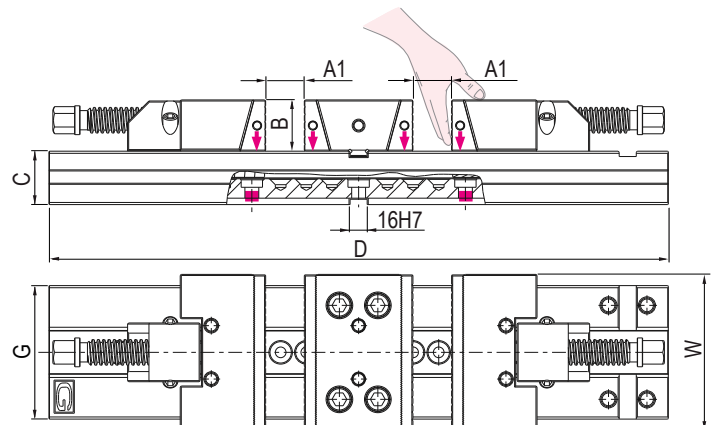
 Vedi gruppo 4 per gamma completa accessori  
 See group 4 for complete range of accessories

5 40 kN					6 40 kN						
2 x 150	2 x 200	2 x 250	2 x 300	2 x 350	2 x 160	2 x 210	2 x 260	2 x 310	2 x 360	2 x 410	2 x 460
196					296						
63					78						
70					78						
805	905	1005	1105	1205	900	1000	1100	1200	1300	1400	1500
170					195						
64	69	74	79	84	95	105	115	125	135	145	155
2.30.A5150	2.30.A5200	2.30.A5250	2.30.A5300	2.30.A5350	2.30.A6160	2.30.A6210	2.30.A6260	2.30.A6310	2.30.A6360	2.30.A6410	2.30.A6460

**UPGRADE YOUR VISE APPLICATIONS THROUGH MODULAR ACCESSORIES !**

4.23.0E501		4.23.0E601
<b>Art. 230E</b>		
H	53	68
H1	10	10
1.21.25000		1.21.26000
<b>Art. 212</b>		
4.23.0B501		4.23.0B601
<b>Art. 230B</b>		
4.23.0F501		4.23.0F601
<b>Art. 230F</b>		
4.39.15000		4.39.16000
<b>Art. 391</b>		
4.39.25000		4.39.26000
<b>Art. 392</b>		

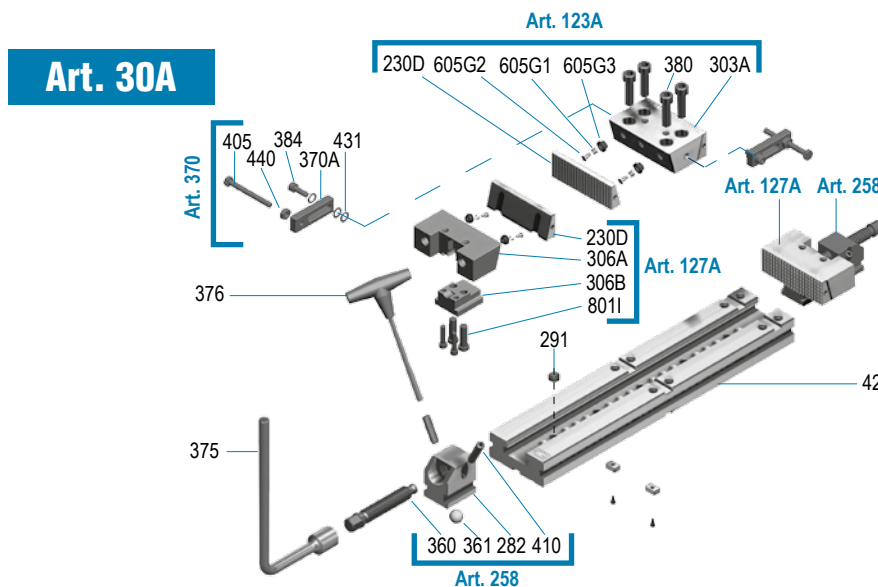
 Pneumo-hydraulic servo units (complete of hydraulic cylinder + support) for multiple clamping *simultaneous* or *independent*, from 2 to 6 vises. See from page 4.36 to 4.47

Art.	Pag.
42	2.30
230D	4.17
282	4.32
291	4.31
297	4.31
303A	4.26
306A	4.26
306B	4.26
360	4.32
361	4.32
370A	4.31
375	4.31

Art.	Pag.
376	4.31
380	4.24
384	4.24
405	4.31
410	4.32
431	4.24
440	4.24
605G1	4.18
605G2	4.18
605G3	4.18
801I	5.61
-	-

Tipo (grandezza) morsa / Vise (type) size

**1**
**2**
**3**
**4**
**Art. 42**

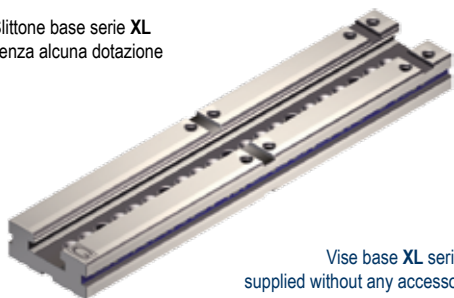
 Slittone base serie **XL**  
 senza alcuna dotazione

 Vise base **XL** series  
 supplied without any accessory

kg	6.6	10.7	20.7	24.7	30.2	34.8	39.3	43.8
Cod.	1.80.11460	1.80.21520	1.80.31580	1.80.31680	1.80.41666	1.80.41766	1.80.41866	1.80.41966

 Versione normale: Cave da 16 mm (H7)  
 Versione opzionale: Fori rettificati e calibrati con tolleranza F7

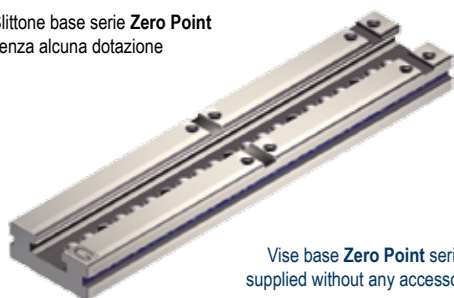
**Art. 42Z**

 Slittone base serie **Zero Point**  
 senza alcuna dotazione

 Vise base **Zero Point** series  
 supplied without any accessory

kg	6.4	10.5	20.5	24.5	29.9	34.5	39	43.5
Cod.	2.42.Z1460	2.42.Z2520	2.42.Z3580	2.42.Z3680	2.42.Z4666	2.42.Z4766	2.42.Z4866	2.42.Z4966

 Versione normale: Cave da 16 mm (H7)  
 Versione opzionale: Fori rettificati e calibrati con tolleranza F7

Tolleranza / Tolerance

- 0,02

C	35	40	50	680	666	766	866	966
D	450	520	580	680	666	766	866	966
F	10	12	13	13			15	
F1	10	10	12	12			18	
G	75	95	125	125			145	
Y	21	28	41	41			51	
Y1	31	41	57	57			70	
M	M10	M12	M14	M14			M16	
N	195	225	252	302	293	343	393	443
N1	35	35	38	38			40	
O	32	32	36	36			36	
P	19	19	20	20			22	
Q	50	62	88	88			100	
T	9,5	9,5	11,5	11,5			11,5	
T1	15	15	20	20			20	
T2	5	5	7	7			7	
Z	100	100	100	100			100	

**Art. 42**

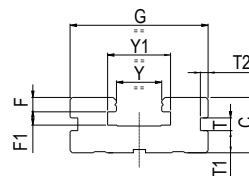
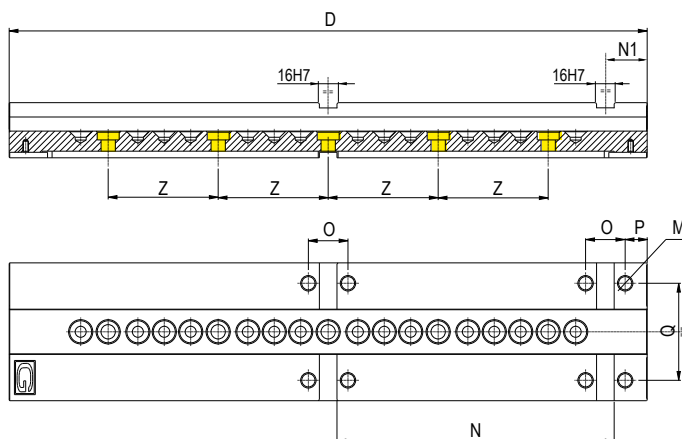
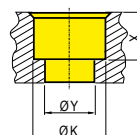
 Slittone base serie **XL** / Vise base **XL** series

**Dettaglio foro per vite TCEI / TCEI screw hole details**

Type	1	2	3	4	5	6
X	4,5	5,5	8	8	17	17
ØY	6,5	8,5	13	13	17	17
ØK	10,5	13,5	19	19	26	26

**5**
**6**

64	69	74	79	84	95	105	115	125	135	145	155
1.80.51805	1.80.51905	1.80.51005	1.80.51105	1.80.51205	1.80.61900	1.80.61000	1.80.61100	1.80.61200	1.80.61300	1.80.61400	1.80.61500

 Normal version: 16 mm slots (H7)  
 Optional version: Ground calibrated holes F7 tolerance

60	65	70	75	80	91	101	111	121	131	141	151
2.42.Z5805	2.42.Z5905	2.42.Z5005	2.42.Z5105	2.42.Z5205	2.42.Z6900	2.42.Z6100	2.42.Z6110	2.42.Z6120	2.42.Z6130	2.42.Z6140	2.42.Z6150

 Normal version: 16 mm slots (H7)  
 Optional version: Ground calibrated holes F7 tolerance

		70								78		
805	905	1005	1105	1205	900	1000	1100	1200	1300	1400	1500	
		20								20		
		18								18		
		170								195		
		61								71		
		80								90		
		M20								M20		
357,5	407,5	457,5	507,5	557,5	405	455	505	555	605	655	707	
		45								45		
		44								44		
		23								23		
		120								133		
		17,5								17,5		
		26								26		
		10								10		
		100								100		

**Art. 42Z**

Slittone base serie Zero Point / Vise base Zero Point series

Tolleranze generiche per morse XL / XL vise generic tolerances

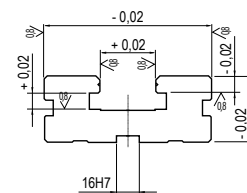
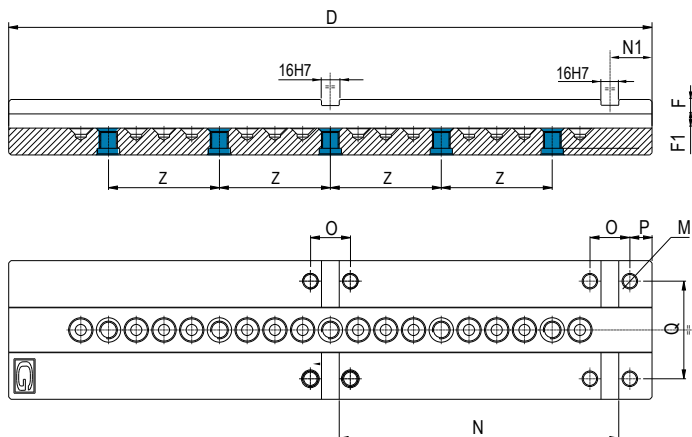
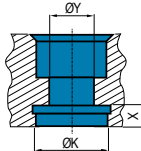
**Dettaglio foro per Zero Point / Zero Point hole details**

Type	1	2	3	4	5	6
X						6
Y	M16	M16	M16	M16	M16	M16
Ø K						20

# DIAGRAMMI SERRAGGIO MECCANICO CON CHIAVE DINAMOMETRICA

## DIAGRAMS MECHANICAL CLAMPING WITH TORQUE WRENCH

2



### GRUPPI DI SERRAGGIO MECCANICI

( **Art. 258** e similari )

I diagrammi seguenti consentono di determinare le forze di serraggio ottenibili con le morse di varia grandezza (da 1 a 6), in funzione del momento applicato

### MECHANICAL CLAMPING DEVICES

( **Art. 258** and similar )

The following diagrams give the clamping force that can be obtained with each vise type (size 1 to 6) depending on the torque

### MORSE MODULARI XL TIPO 1

#### XL MODULAR VISES TYPE

Vite M12 - Passo 1,75mm  
 Screw M12 - Pitch 1,75mm

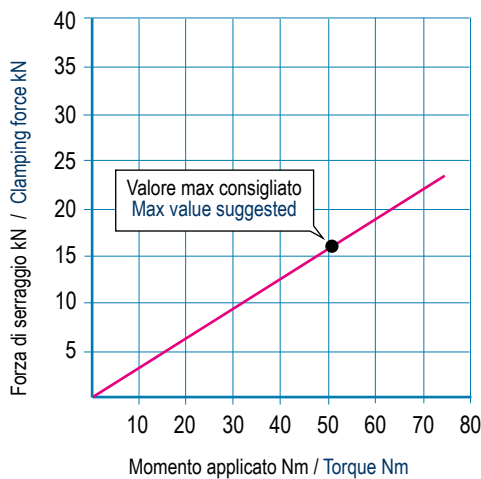

### MORSE MODULARI XL TIPO 2

#### XL MODULAR VISES TYPE

Vite TPN18 - Passo 4mm  
 Screw TPN18 - Pitch 4mm

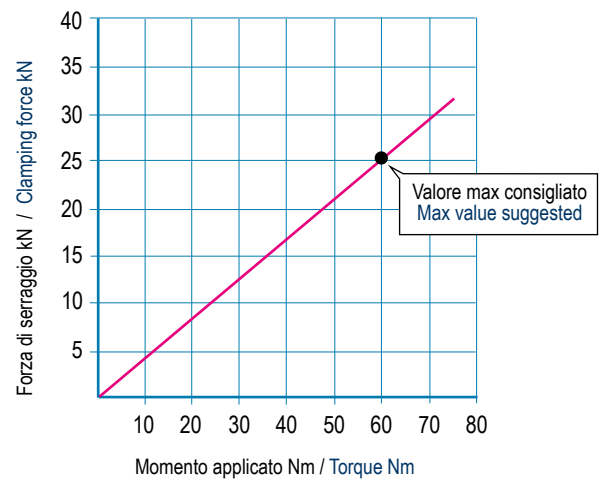

### MORSE MODULARI XL TIPO 3-4

#### XL MODULAR VISES TYPE

Vite TPN24 - Passo 5mm  
 Screw TPN24 - Pitch 5mm

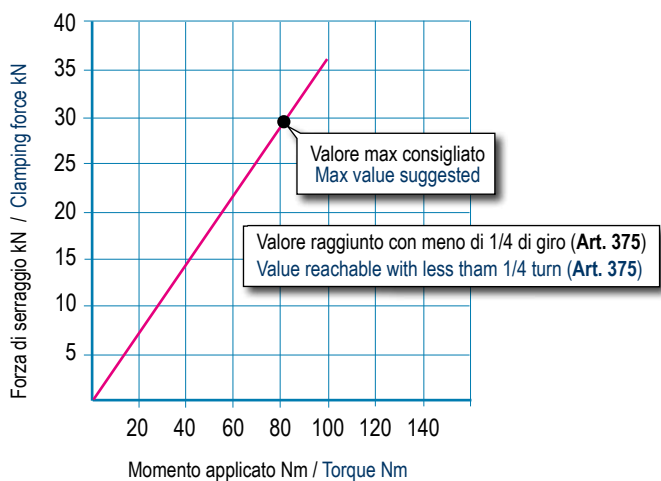

### MORSE MODULARI XL TIPO 5-6

#### XL MODULAR VISES TYPE

Vite TPN30 - Passo 5mm  
 Screw TPN30 - Pitch 5mm

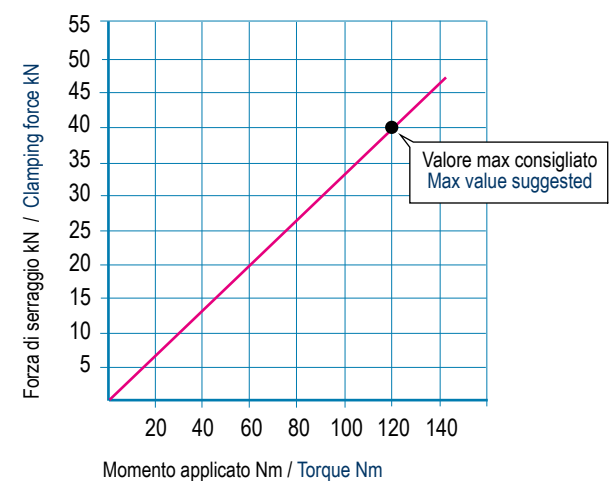

NB: Alcuni fattori, come la lubrificazione, lo staffaggio, gli attriti ed altro, possono modificare i valori indicati fino a  $\pm 10\%$ .  
 Per un corretto utilizzo non superare i valori indicati nel grafico

Some factor as lubrication, clamping on the machine table, frictions and more can modify above values within a  $\pm 10\%$  range. For optimum operation do not exceed chart values.